



CHARRELL

FURNITURE COLLECTION



Materials & finishes

Varied range of
carefully selected,
high-quality materials.

04

Contemporary collection

A beautifully curated
collection, rooted in today's
looks and preferences.

14

Classic collection

Established values
that radiate an atmosphere
of rural cosiness.

182

Technical information

Sofas &
ceramic tables

222



LET US
INSPIRE
YOU

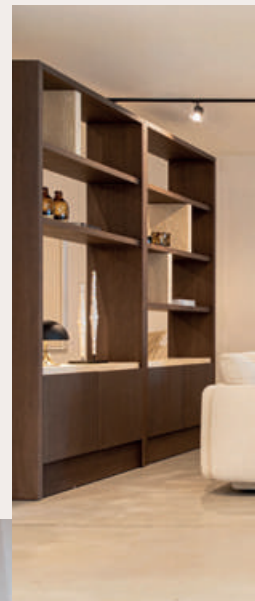



Graag verwelkomen we je in onze nieuwe catalogus. Een feestelijke editie, want we zijn trots om onze nieuwste items voor te stellen, in het kader van onze pas uitgebreide showroom. Met deze extra 600 m² aan oppervlakte willen we je onderdompelen in een sfeervolle setting vol inspiratie.

Ontworpen met het oog op tijdloze klasse, wordt een groot deel van onze meubels met de hand vervaardigd, in natuurlijke materialen. Daardoor kunnen we een grote waaier aan afwerkingen bieden, met de mogelijkheid om af te wijken van de standaard maten.

Dankzij de gastvrijheid van onze klanten laten we je ook binnenkijken in onze realisaties. Je kan de volledige reportages bekijken op onze website: www.charrell.be/projecten-realisaties. Onze interieurarchitecten staan klaar met professioneel advies en begeleiden je met veel plezier om de unieke Charrell-stempel op jouw interieur te drukken.

Veel leesplezier en wees steeds welkom in onze vernieuwde conceptstore te Geel!

Team Charrell



We would like to welcome you to our new catalogue. A festive edition, as we are proud to present our latest items, in the context of our newly expanded showroom. With this extra 600 m² of floor space, we aim to immerse you in an atmospheric setting full of inspiration.

Designed with timeless class in mind, much of our furniture is made by hand, in natural materials. This allows us to offer a wide range of finishes, with the possibility of deviating from standard sizes.

Thanks to the hospitality of our customers, we also let you look inside our realisations. You can view full reports on our website: www.charrell.be/en/interior-projects-realizations. Our interior architects are ready with professional advice and will gladly guide you add that signature Charrell touch to your interior.

Enjoy reading and always be welcome in our renovated concept store in Geel!

Team Charrell

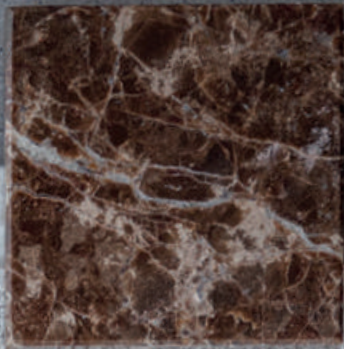

MATERIALS & FINISHES

De kwaliteitsvolle meubels van Charrell worden in verschillende Europese fabrieken vervaardigd*. Dit levert een mooi en gevarieerd aanbod op aan materialen en afwerkingen. Naast het vertrouwde eikenhout en marmer maken nu ook notelaar, travertin, keramiek, mortex en zelfs gelakte meubels deel uit van ons gamma.

Charrell's quality furniture is manufactured in several European factories*. This results in a beautiful and varied range of materials and finishes. Besides the familiar oak and marble, our range has been extended with walnut, travertine, ceramic, mortex and even lacquered furniture.

* De productiesite wordt in het artikelnummer weergegeven door -RO, -MO, -IF of -CO
* The production site is listed as -RO, -MO, -IF or -CO in the item number

MO // AUTHENTIC MATERIALS

Waar enkele jaren geleden vooral gewerkt werd met eikenhout en marmer, breidden we het aanbod in ons MO-gamma uit met materialen zoals notelaar, mortex, keramiek en gelakt hout.

Whereas a few years ago we mainly worked with oak and marble, we expanded the range in our MO range to include materials such as walnut, mortex, ceramic and varnished wood.

Oak



sand



natural oak

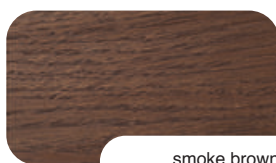

smoke brown



coffee



cacao

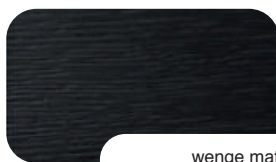

wenge mat

Walnut



walnut

NATURAL FEATURES

Notelaar is een donkere, warmkleurige houtsoort van hoogstaande kwaliteit. De karakteristieke gevlamde tekening maakt elk meubel uniek. Met haar donkere elegantie en vintage look geeft zij elk interieur een exclusieve uitstraling.

Walnut is a dark, warm-coloured high-quality wood. Its characteristic flamed pattern makes each piece of furniture unique. With its dark elegance and vintage look, it gives every interior an exclusive look.



Marble

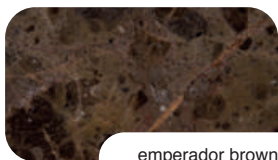

emperador brown

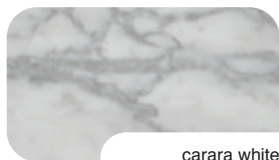

carara white



black

Travertine



natural



beige

Natuursteen is hipper dan ooit in onze interieurs. Naast marmer maakt ook travertin zijn comeback. Deze bijzondere kalksteen wordt gevormd in warmwater bronnen. De gelaagde structuur en kenmerkende poriën geven hem zijn natuurlijke schoonheid.

Natural stone is hipper than ever in our interiors. Besides marble, travertine is also making a comeback. This particular limestone is formed in hot springs. Its layered structure and distinctive pores give it its natural beauty.



Mortex



natural



beige



black



Laquered

RAL kleur naar keuze,
mat of blinkend

RAL colour of your choice,
matt or shiny



Mortex is een decoratieve pleister op basis van cement en kalk waarmee een mooi effect kan bekomen worden op meubeloppervlakken. Het leent zich perfect tot het creëren van organische, vloeiende vormen.

Mortex is a decorative plaster based on cement and lime that can be used to obtain a beautiful effect on furniture surfaces. It lends itself perfectly to creating organic, flowing shapes.

RO // STRONG & DURABLE OAK

In de trendgevoelige interieurbranche blijft eik een sterkhouders. De natuurlijke, authentieke uitstraling van het materiaal geeft moeiteloos klasse aan elk interieur. Eik laat zich daarnaast graag bewerken en is bovendien geschikt om te kleuren, roken of branden om zo de gewenste look te creëren.

In the trend-setting interior design industry, oak remains a stronghold. The material's natural, authentic look effortlessly adds class to any interior. Oak is also easy to work with and can be coloured, smoked or burnt to create the desired look.

Oak



white wash



natural oak



stone



grey oak



tobacco



swamp

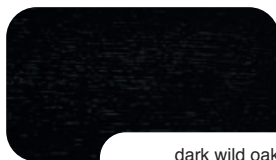

dark wild oak

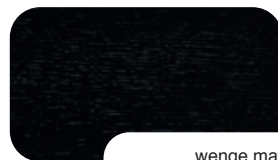

wenge mat



DESIRED LOOK

Eik is een duurzaam, natuurlijk materiaal. De aanwezigheid van nerven, noesten en de robuuste structuur zorgt voor zijn eigenheid. De uiteindelijke look en afwerking kies je zelf.

Oak is a durable, natural material. The presence of grains, knots and its robust structure creates its individuality. You choose the final look and finish.

IF // MATERIALS MATTER

De designs uit onze IF-collectie zijn eigentijds elegant. De basis: eikenhout, notelaar of gelakt hout met als optie een topping in keramiek. Deze op zichzelf sterkstaande materialen geven gecombineerd een waaier aan mogelijkheden.

The designs in our IF collection are contemporary elegant. The base: oak, walnut or varnished wood with an optional topping in ceramic. These stand-alone materials combined give a wide range of possibilities.

Oak



Walnut



Laquered

RAL kleur naar keuze,
mat of blinkend

RAL colour of your choice,
matt or shiny

Ceramic

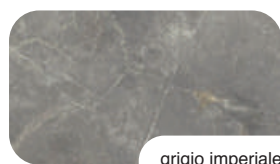
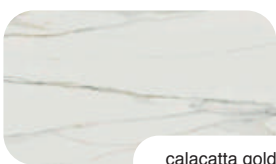

CO // THE BEAUTY OF CERAMICS

De keramische tafels uit onze CO-collectie zijn samengesteld uit een hoogwaardig keramieken blad en een stalen poot. De bladen kenmerken zich door een luxe uitstraling met prachtige marmerlooks. De combinatiemogelijkheden zijn zeer uitgebreid. Voor zowel het blad als het onderstel zijn verschillende vormen, kleuren en afwerkingen mogelijk.

The ceramic tables from our CO collection are composed of a high-quality ceramic top and a steel leg. The tops are characterised by a luxurious appearance with beautiful marble looks. The combination options are very extensive. Various shapes, colours and finishes are possible for both the top and the base.



SOLID AND REFINED

De keramische bladen zijn vervaardigd uit 100% natuurlijke en milieuvriendelijke materialen. De klei wordt onder extreem hoge druk geperst voordat deze op hoge temperatuur wordt gebakken. Hierdoor ontstaat een licht materiaal dat ook nog eens absoluut sterk is. Daarnaast ziet het bewerkte keramiek er erg mooi en strak uit.

De keramische tafels zijn bestand tegen krassen, chemicaliën en alkaliën, hitte, vorst en UV-stralen. Ze zijn ook heel gemakkelijk schoon te maken.

The ceramic table tops are made from a 100% natural and eco-friendly material. The clay is pressed under extremely high pressure before it is fired at a high temperature. This creates a light material that is also absolutely strong. In addition, the processed ceramics look very nice and sleek. The ceramic tables are resistant to scratches, chemicals and alkalis, heat, frost and UV rays. They are also very easy to clean.

Your table – your choices

Afhankelijk van de grootte van het blad bieden wij een ruime keuze aan kleuren in een matte, glanzende (B) of semi-satijne afwerking. De bladen bestaan in verschillende vormen, die gecombineerd kunnen worden met meerdere ontwerpen van stalen poten. Ontdek de mogelijkheden op p. 282.

Depending on the size of the top, we offer a wide choice of colors in a matt, glossy (B) or semi satin finish. The tops come in different shapes, which can be combined with multiple designs of steel legs. Discover the possibilities on p. 282.

Max. 240 x 120 cm

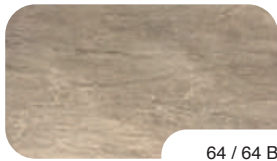

64 / 64 B



200 / 200 B

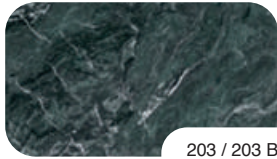

203 / 203 B



950

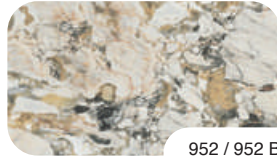

952 / 952 B

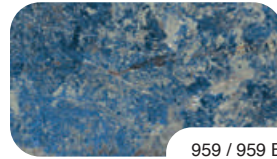

959 / 959 B



95



600 P

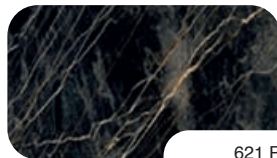

621 P

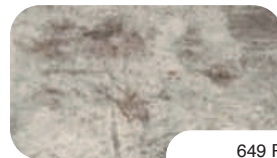

649 P



650 P

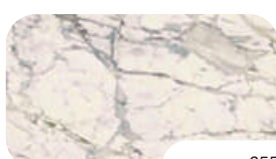

655



655 P



796



955

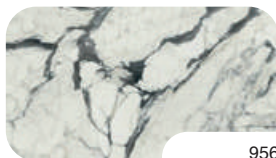

956

Max. 280 x 120 cm

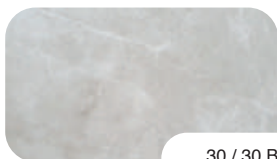

30 / 30 B



62



65



75 / 75 B



78



81



500



502

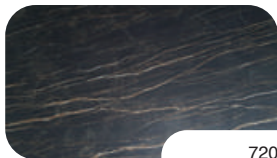

720



721

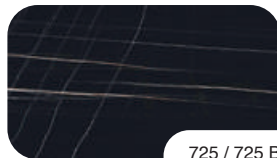

725 / 725 B



781



902

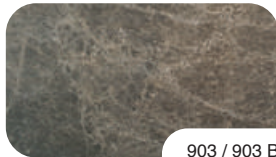

903 / 903 B

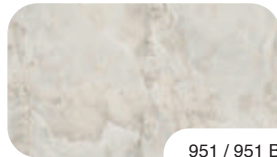

951 / 951 B



958

Max. 320 x 160 cm

STYLISH FABRICS

Elke stoel, seat en sofa in ons aanbod wordt met de grootste zorg vervaardigd. Je kan de uitstraling van de stoel bepalen door te kiezen uit verschillende stoffen/leders.

Every chair, seat and sofa in our range is manufactured with the greatest care. You can determine the look of the chair by choosing from different fabrics/leathers.



COMBINE MATERIALS

Stoffen zijn erg bepalend voor de look van het interieur. Structuren en kleuren van alle materialen samen, kunnen elkaar aanvullen en versterken. Stoffen kunnen een design kracht bij zetten voor welke sfeer men dan ook wil bekomen.

We helpen u graag bij het maken van de juiste keuzes en combinaties.

Fabrics are very decisive for the look of the interior. Structures and colours of all materials together can complement and enhance each other. Fabrics can enhance a design for whatever atmosphere you want to achieve.

We are happy to help you make the right choices and combinations.

A LA CARTE

De collecties 'CHI', 'BP' en 'PE' kunnen à la carte gestoffeerd worden, met keuze uit wel 1.000 verschillende stoffen en leders. Ook bij modellen waar een bepaald keuzeaanbod aan stoffen geldt, bieden we de mogelijkheid aan om à la carte te kiezen.

De stoelen uit collecties 'DF', 'YL' en 'IN' hebben daarentegen een beperkter gamma.

Vraag info in onze conceptstore!

The 'CHI', 'BP' and 'PE' collections can be upholstered à la carte, with a choice of up to 1,000 different fabrics and leathers. We also offer the option of choosing à la carte for models with a specific fabric selection.

By contrast, the chairs from collections 'DF', 'YL' and 'IN' have a more limited range.

Ask for info in our concept store!



CONTEMPORARY COLLECTION

Eigentijdse meubels die beantwoorden aan de hedendaagse trends en behoeften, dat is waar onze 'Contemporary collection' voor staat. Zoals steeds met keuze uit verschillende vernieuwende materialen, vormen en kleuren.

Contemporary furniture that meets the trends and needs of life today, that's what our 'Contemporary collection' stands for. As always with a choice of various innovative materials, shapes and colours.



16

Cabinets

- 18 Storage & bar cabinets
- 28 Display cabinets
- 30 Bookcases
- 32 Shelving units
- 38 Sideboards
- 48 Tv cabinets

58

Tables & side furniture

- 60 Dining tables
- 78 Coffee tables
- 92 Consoles
- 104 Side tables
- 112 Sofa side furniture
- 116 Stands
- 118 Desks
- 124 Night tables



126

Chairs

- 128 Dining chairs
- 138 Counter chairs

142

Seats & sofas

- 144 Seats
- 162 Sofas

Cabinets

De kunst van het creëren van opbergruimte met oog voor esthetiek en balans. Stijl en trends ontmoeten elkaar in tijdloze opbergmeubels.

The art of creating storage space with an eye for aesthetics and balance. Style and trends meet in timeless storage furniture.

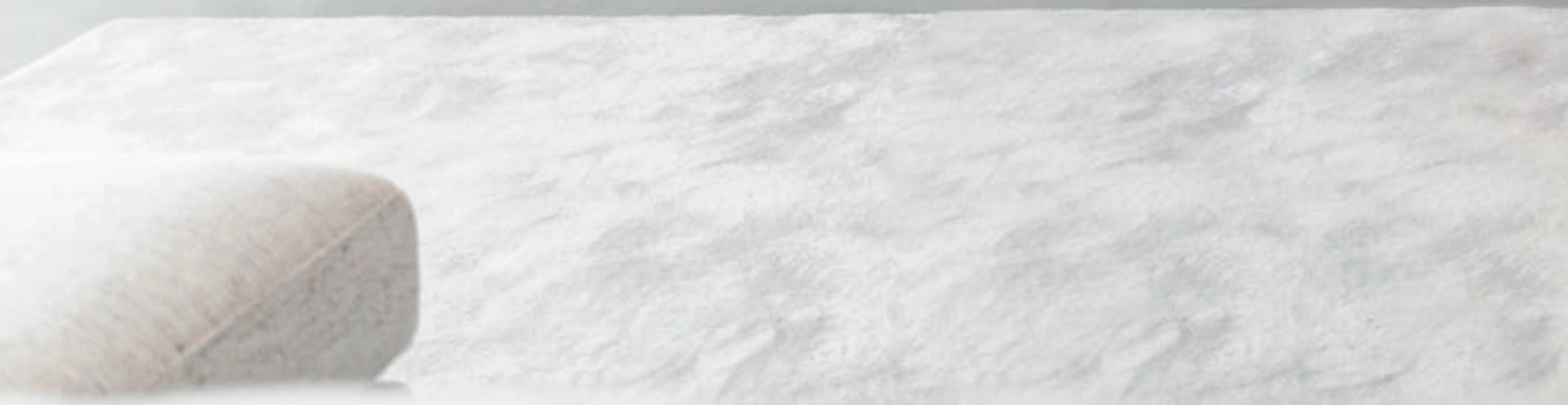
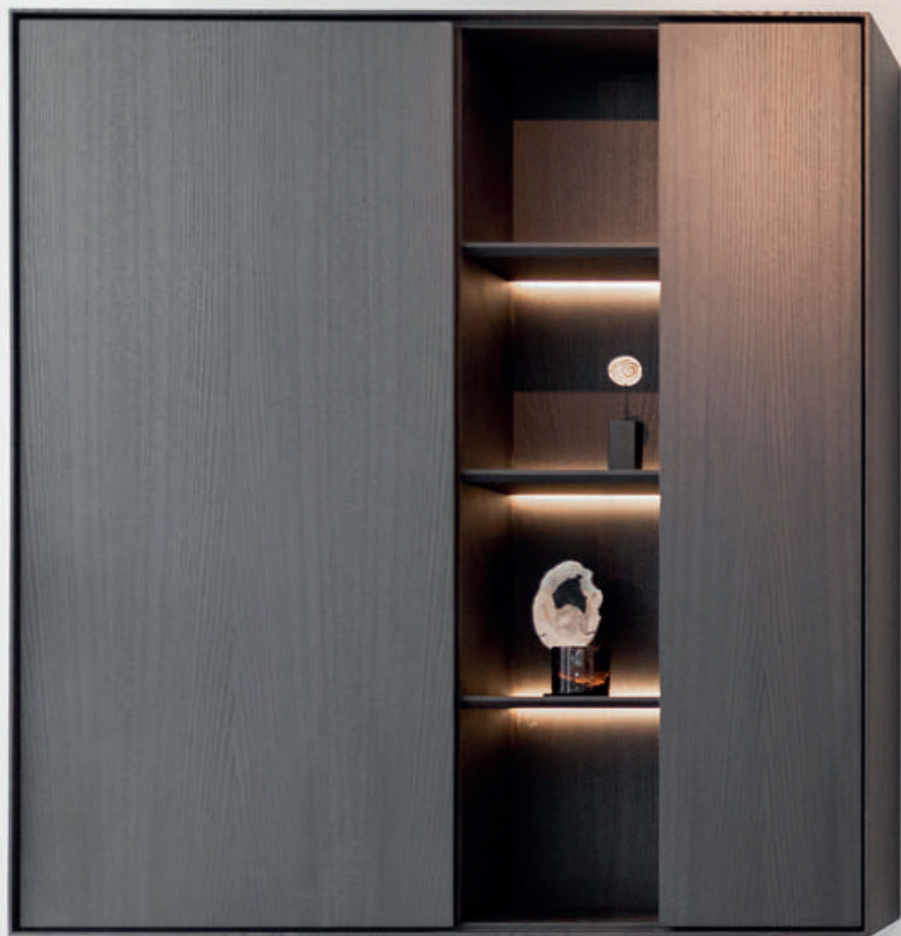

Storage & bar cabinets



Blikvanger: de contrasterende tussenstukken in travertijn of marmer geven het geheel een exclusieve, vintage feel.

Eye-catcher: the contrasting intermediate pieces in travertine or marble give the whole an exclusive, vintage feel.



Cosmo



Oak veneer / travertine

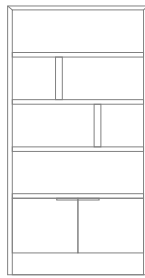

CABINET COSMO SHELVES
W 130 - D 40 - H 250 CM
CAB95677-MO

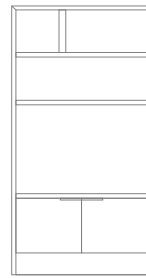

CABINET COSMO OPEN
W 130 - D 40 - H 250 CM
CAB95678-MO



Paloma



Oak veneer / marble

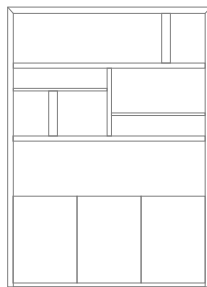

CABINET PALOMA
W 160 - D 45 - H 220 CM
CAB95664-MO



Starring personality

De invulling van een ruimte met meubels waarbij stijl en functie hand in hand gaan, dat is de ideale formule voor een geslaagd interieur. Een cabinet met open delen geeft je de kans je persoonlijkheid 'on display' te zetten.

Filling a room with furniture in which style and function go hand in hand is the ideal formula for a successful interior. A cabinet with open sections allows you to put your personality on display.





Party mode *ON*

Ondanks de grote opbergcapaciteit oogt het design van de cabinets elegant en luchtig. Het gebruik van metaal voor de poten of het frame zorgt voor deze verfijning. Deze barkast is de ideale wingman tijdens cocktail - en andere - parties!

Despite the large storage capacity, the design of the cabinets looks elegant and airy. The use of metal for the legs or frame ensures this sophistication. This bar cabinet is the ideal wingman during cocktail - and other - parties!

Flinn



Oak veneer

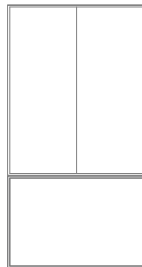

CABINET FLINN 2D
W 105 - D 40 - H 200 CM
CAB97490-MO

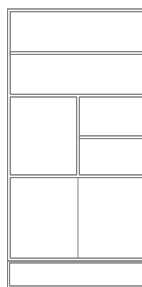

CABINET FLINN BAR - S
W 102 - D 45 - H 206 CM
CAB96132-MO

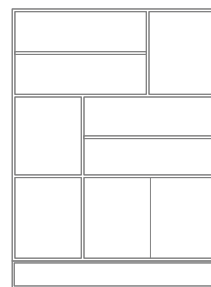

CABINET FLINN BAR - L
W 152 - D 45 - H 206 CM
CAB96163-MO

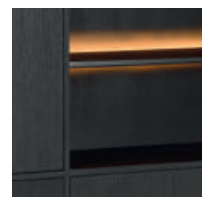



Orly



Oak veneer

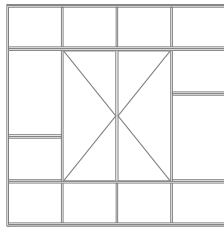

CABINET ORLY
W 200 - D 45 - H 200 CM
CAB96068-MO



Yadi



Oak veneer

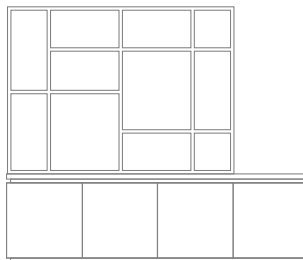

CABINET YADI
W 240 - D 45 - H 220 CM
CAB95631-MO



Osaka



Oak veneer

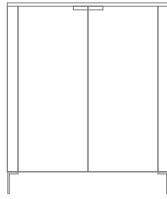

CABINET OSAKA BAR
W 110 - D 45 - H 130 CM
CAB95665-MO



Lexon



Oak veneer / marble

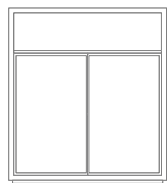

CABINET LEXON LOW/OPEN
W 125 - D 45 - H 140 CM
CAB96633-MO



CABINET LEXON LOW/OPEN - MARBLE
W 125 - D 45 - H 140 CM
CAB96632-MO

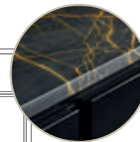

Bridge



Oak veneer / marble

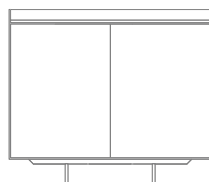

CABINET BRIDGE
W 115 - D 45 - H 135 CM
CAB96408-MO



CABINET BRIDGE - MARBLE
W 115 - D 45 - H 135 CM
CAB96590-MO

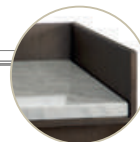



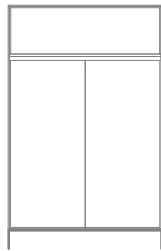

CABINET VERSO OPEN 195
W 115 - D 45 - H 195 CM
CAB97700-MO

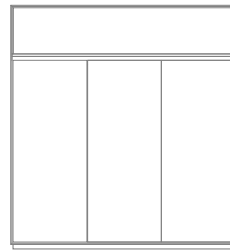

CABINET VERSO 195 - 3D ON SOCCLE
W 170 - D 45 - H 195 CM
CAB96592-MO

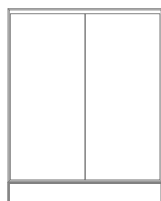

CABINET VERSO 155
W 115 - D 45 - H 155 CM
CAB97699-MO



Choose wise

Bij het inrichten moét je nadenken over opberging. Traditioneel heb je die namelijk nooit genoeg. Hoe zorg je ervoor dat het geheel niet te zwaar wordt in kleinere ruimtes? Ga voor een exemplaar op pootjes. Kies een cabinet dat niet te hoog is en plaats twee identieke stukken naast elkaar in de plaats van één groot exemplaar.

When furnishing your home, you have to think about storage. Traditionally, you never have enough. How do you make sure it doesn't get too heavy in smaller rooms? Go for one that stands on legs. Choose a cabinet that is not too high and place two identical pieces next to each other instead of one large one.



Mezzo

Massive oak / oak veneer

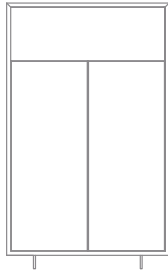

CABINET MEZZO OPEN
W 120 - D 45 - H 200 CM
CAB97693-RO



Maddox

Oak veneer

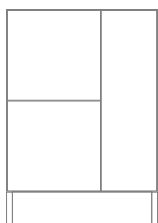

**CABINET MADDOX
3 DOORS RIGHT**
W 100 - D 45 - H 145 CM
CAB97465-MO



**CABINET MADDOX
3 DOORS LEFT**
W 100 - D 45 - H 145 CM
CAB97466-MO







Moxy

Oak veneer

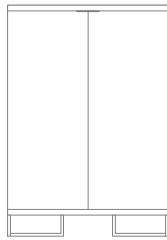

CABINET MOXY
2 PARTS
W 115 - D 45 - H 165 CM
CAB96124-MO



Dundee



Oak veneer

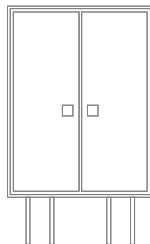

CABINET DUNDEE
2 PARTS
W 110 - D 45 - H 180 CM
CAB97112-MO



Black & gold...

... een combinatie die blijft verrassen. De vierkante handgrepen versterken hier het eigenzinnige karakter van de cabinet Dundee.

... a combination that continues to surprise. Here, the square handles enhance the quirky character of the cabinet Dundee.

Display cabinets



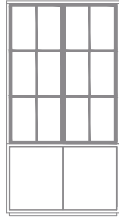

CABINET MEZZO 2 PARTS
W 125 - D 50 - H 225 CM
CAB97878-RO

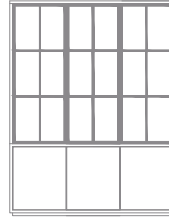

CABINET MEZZO 3 PARTS
W 180 - D 50 - H 225 CM
CAB97877-RO

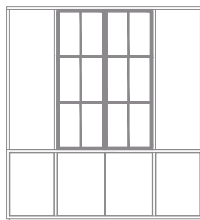

CABINET MEZZO 4 PARTS 210
W 210 - D 50 - H 225 CM
CAB97661-RO

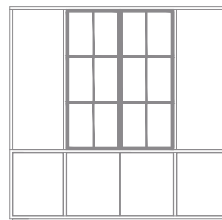

CABINET MEZZO 4 PARTS 240
W 240 - D 50 - H 225 CM
CAB97879-RO

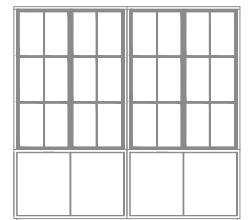

CABINET MEZZO 4 PARTS 240 ALL GLASS
W 240 - D 50 - H 225 CM
CAB97682-RO

De Charrell meubels worden op bestelling met de hand vervaardigd. Hierdoor worden eventuele aanpassingen aan afmetingen, details en indeling mogelijk gemaakt.

The Charrell pieces are hand-crafted to order: allowing for adjustments to dimensions, details, and layout.



Bookcases



Lexon



Oak veneer



BOOKCASE LEXON 115
W 115 - D 40 - H 230 CM
CAB97718-MO

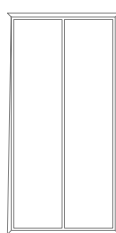

BOOKCASE LEXON 115
PLAIN DOORS
W 115 - D 40 - H 230 CM
CAB97841-MO

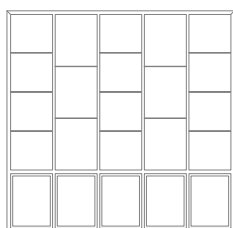

BOOKCASE LEXON 250
5 PARTS
W 250 - D 40 - H 230 CM
CAB97743-MO

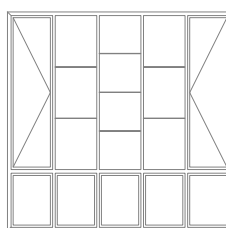

BOOKCASE LEXON 250
5 PARTS - MIDDLE OPEN
W 250 - D 40 - H 230 CM
CAB95545-MO



Ons opbergassortiment is fel uitgebreid met half open kasten die ons hedendaags leven aangenaam maken. De nieuwste toevoeging aan de Lexon collectie is deze prachtige wandvullende bookcase.

Our storage range has been expanded with half open cupboards that make our contemporary life pleasant. The latest addition to the Lexon collection is this beautiful wall-filling bookcase.

Stylish
storage

Shelving units





De 3 racks Plaza zijn speciaal ontworpen om zowel alleenstaand als in combinatie met elkaar te shinen!

The 3 racks Plaza are specially designed to shine, either as single units or combined together!

Plaza



Oak veneer



**RACK PLAZA 50
DRAWER**
W 50 - D 40 - H 200 CM
CAB96725-RO

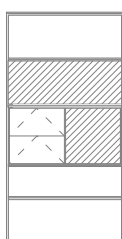

**RACK PLAZA 100
DRAWERS**
W 100 - D 40 - H 200 CM
CAB96726-RO

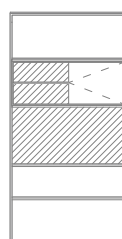

**RACK PLAZA 100
1 DOOR**
W 100 - D 40 - H 200 CM
CAB96727-RO

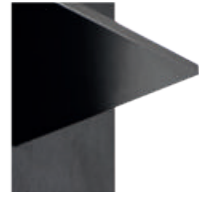
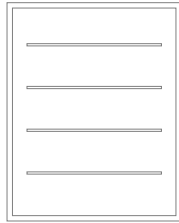

RACK TORRES HANGING
W 130 - D 29 - H 162 CM
CAB95673-MO

LESS is all you need

Een eikenhouten achterwand en metalen schappen. Meer heeft het rack Torres niet om het lijf. En juist daarom maakt hij ons helemaal happy!

An oak back wall and metal shelves. That's all rack Torres has to offer. And that is precisely why he makes us completely happy!



Flinn



Oak veneer

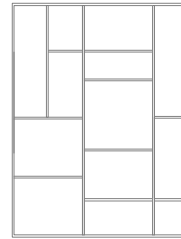
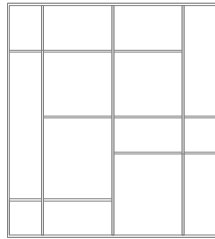

RACK FLINN
W 180 - D 35 - H 200 CM
CAB97489-MO

RACK FLINN
W 150 - D 35 - H 200 CM
CAB96162-MO



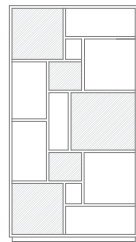

CABINET HUSK RIGHT
W 120 - D 30 - H 220 CM
CAB97470-MO

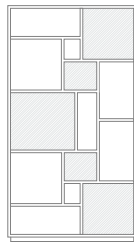

CABINET HUSK LEFT
W 120 - D 30 - H 220 CM
CAB97471-MO



De cabinet Husk laat je ruimte stralen! Door de speelse vormgeving met deels open- en gesloten kastjes, wordt de geometrie in de verf gezet. Het 'reduceren tot de essentie' doet het gedachtengoed van De Stijl alle eer aan.

The cabinet Husk adds radiance to your room! The geometry is emphasised by the playful design with a combination of open and closed cupboards. 'Reduction to essence' really honours the 'De Stijl' philosophy.





Flow

Oak veneer

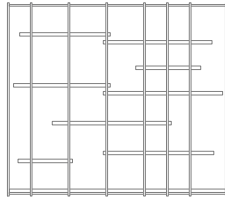

RACK FLOW
W 250 - D 40 - H 220 CM
CAB96687-RO

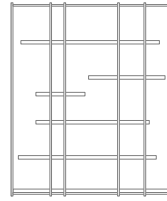

RACK FLOW
W 180 - D 40 - H 220 CM
CAB96161-RO



June



Oak veneer / ceramic

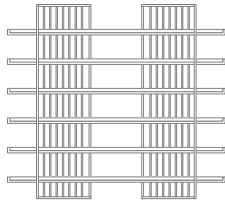
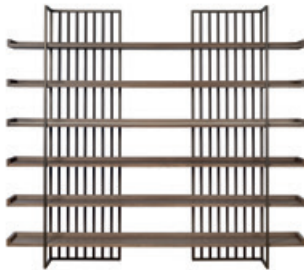

ROOMDIVIDER JUNE
W 180 - D 32 - H 214 CM ACC96234-IF
W 210 - D 32 - H 214 CM ACC96235-IF
W 240 - D 32 - H 214 CM ACC96294-IF

OPTIONAL CERAMIC TOP/PC
ACC96233-IF
ACC96232-IF
ACC96231-IF



Sideboards





Bridge

Oak veneer / marble



Standing



SIDEBOARD BRIDGE
4 DOORS
 W 210 - D 45 - H 75 CM CAB96411-MO
 W 240 - D 45 - H 75 CM CAB96410-MO

SIDEBOARD BRIDGE - MARBLE
4 DOORS
 W 210 - D 45 - H 75 CM CAB96409-MO
 W 240 - D 45 - H 75 CM CAB96591-MO

Hanging

Hanging version:
not possible with marble



SIDEBOARD BRIDGE HANGING
4 DOORS
 W 210 - D 45 - H 55 CM CAB96131-MO
 W 240 - D 45 - H 55 CM CAB96145-MO

Extra opberg ruimte is heel erg praktisch, maar een sideboard draagt ook bij tot de algemene look & feel van de ruimte. Daarom is het belangrijk om de ideale match te vinden tussen uiterlijke én innerlijke schoonheid!

Extra storage space is very practical, but a sideboard also adds to the general look & feel of a space. That is why it is important to strike the perfect balance of outer and inner beauty!



Verso



Oak veneer



Standing



**SIDEBOARD VERSO 180
4 DOORS**
W 180 - D 45 - H 85 CM
CAB98128-MO



**SIDEBOARD VERSO 210
4 DOORS**
W 210 - D 45 - H 85 CM
CAB98129-MO



**SIDEBOARD VERSO 240
4 DOORS**
W 240 - D 45 - H 85 CM
CAB98130-MO

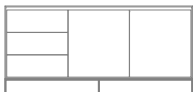

**SIDEBOARD VERSO 180
2 DOORS / 3 DRAWERS**
W 180 - D 45 - H 85 CM
CAB98125-MO

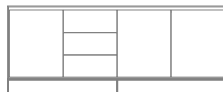

**SIDEBOARD VERSO 210
3 DOORS / 3 DRAWERS**
W 210 - D 45 - H 85 CM
CAB98126-MO

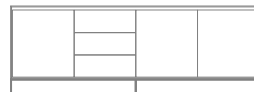

**SIDEBOARD VERSO 240
3 DOORS / 3 DRAWERS**
W 240 - D 45 - H 85 CM
CAB98127-MO

Hanging



**SIDEBOARD VERSO 180 HANGING
4 DOORS**
W 180 - D 45 - H 55 CM
CAB98122-MO



**SIDEBOARD VERSO 210 HANGING
4 DOORS**
W 210 - D 45 - H 55 CM
CAB98123-MO



**SIDEBOARD VERSO 240 HANGING
4 DOORS**
W 240 - D 45 - H 55 CM
CAB98124-MO



**SIDEBOARD VERSO 180 HANGING
2 DOORS / 3 DRAWERS**
W 180 - D 45 - H 55 CM
CAB98119-MO

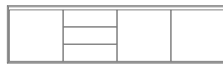

**SIDEBOARD VERSO 210 HANGING
3 DOORS / 3 DRAWERS**
W 210 - D 45 - H 55 CM
CAB98120-MO

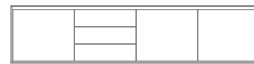

**SIDEBOARD VERSO 240 HANGING
3 DOORS / 3 DRAWERS**
W 240 - D 45 - H 55 CM
CAB98121-MO

Define the style

Kies je voor lijnen in de fronten of liever voor vlakke deuren? Het bepalen van deze kleine stijlelementen zal de algemene sfeer in de ruimte mee beïnvloeden. Daarom denken wij graag mee om alles te doen kloppen.

Do you opt for lines in the fronts or prefer flat doors? Determining these small style elements will help influence the overall mood of the room. That is why we like to think with you to make everything match.







Maddox

Oak veneer



Standing

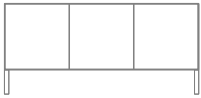

**SIDEBOARD MADDOX
3 DOORS**
W 180 - D 45 - H 85 CM
CAB96784-MO



**SIDEBOARD MADDOX
4 DOORS**
W 210 - D 45 - H 85 CM CAB97406-MO
W 240 - D 45 - H 85 CM CAB97467-MO

Hanging



**SIDEBOARD MADDOX HANGING
3 DOORS**
W 180 - D 45 - H 55 CM
CAB96783-MO



**SIDEBOARD MADDOX HANGING
4 DOORS**
W 210 - D 45 - H 55 CM CAB96874-MO
W 240 - D 45 - H 55 CM CAB96875-MO

Plaza



Oak veneer

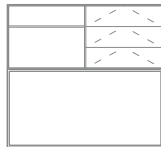

**SIDEBOARD PLAZA
3 DRAWERS**
W 120 - D 40 - H 110 CM
CAB96724-RO





Door zijn strakke lijnen en greeploze fronten vormt deze sobere, stoere sideboard een mooie basis voor kunst en decoratie.

With its clean lines and handleless fronts, this understated and rugged sideboard is a great platform for displaying art and interesting items.

Standing



**SIDEBOARD LEXON 180
3 DOORS**
W 180 - D 45 - H 85 CM
CAB97850-MO



**SIDEBOARD LEXON 210
4 DOORS**
W 210 - D 45 - H 85 CM
CAB97851-MO



**SIDEBOARD LEXON 240
4 DOORS**
W 240 - D 45 - H 85 CM
CAB97852-MO



**SIDEBOARD LEXON 180
OPEN / 3 DOORS**
W 180 - D 45 - H 85 CM
CAB97847-MO



**SIDEBOARD LEXON 210
OPEN / 4 DOORS**
W 210 - D 45 - H 85 CM
CAB97848-MO



**SIDEBOARD LEXON 240
OPEN / 4 DOORS**
W 240 - D 45 - H 85 CM
CAB97849-MO

Hanging



**SIDEBOARD LEXON 180 HANGING
3 DOORS**
W 180 - D 45 - H 55 CM
CAB97844-MO



**SIDEBOARD LEXON 210 HANGING
4 DOORS**
W 210 - D 45 - H 55 CM
CAB97845-MO



**SIDEBOARD LEXON 240 HANGING
4 DOORS**
W 240 - D 45 - H 55 CM
CAB97846-MO



Dundee

Oak veneer

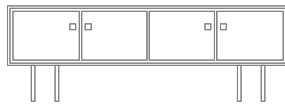

SIDEBOARD DUNDEE
4 DOORS
 W 195 - D 45 - H 80 CM CAB97031-MO
 W 215 - D 45 - H 80 CM CAB97032-MO
 W 235 - D 45 - H 80 CM CAB97033-MO



Chavier



Oak veneer

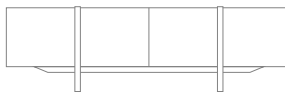

SIDEBOARD CHAVIER
4 DOORS
 W 210 - D 45 - H 70 CM TBL95686-MO
 W 240 - D 45 - H 70 CM TBL95687-MO



Mezzo



Massive oak / oak veneer



Standing

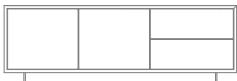

**SIDEBOARD MEZZO
2 DOORS / 2 DRAWERS**
W 210 - D 45 - H 80 CM CAB97873-RO
W 240 - D 45 - H 80 CM CAB97874-RO



**SIDEBOARD MEZZO
4 DOORS**
W 210 - D 45 - H 80 CM CAB97672-RO
W 240 - D 45 - H 80 CM CAB97876-RO

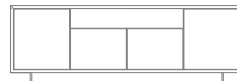

**SIDEBOARD MEZZO
4 DOORS / OPEN**
W 210 - D 45 - H 80 CM CAB97667-RO
W 240 - D 45 - H 80 CM CAB97875-RO

Hanging



**SIDEBOARD MEZZO HANGING
2 DOORS / 2 DRAWERS**
W 210 - D 45 - H 55 CM CAB97668-RO
W 240 - D 45 - H 55 CM CAB97669-RO



**SIDEBOARD MEZZO HANGING
4 DOORS**
W 210 - D 45 - H 55 CM CAB97670-RO
W 240 - D 45 - H 55 CM CAB97671-RO

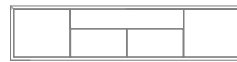

**SIDEBOARD MEZZO HANGING
4 DOORS / OPEN**
W 210 - D 45 - H 55 CM CAB97665-RO
W 240 - D 45 - H 55 CM CAB97666-RO



Moxy



Oak veneer

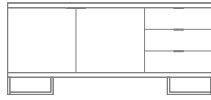

SIDEBOARD MOXY 180
2 DOORS / 3 DRAWERS
W 180 - D 40 - H 80 CM
CAB97028-MO

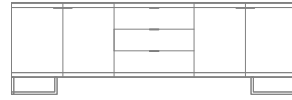

SIDEBOARD MOXY
4 DOORS / 3 DRAWERS
W 210 - D 40 - H 80 CM
W 250 - D 40 - H 80 CM

CAB97029-MO
CAB97131-MO



Tv cabinets



Ribble

Oak veneer



Standing

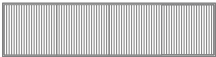

**TV CABINET RIBBLE HANGING
4 DOORS**
W 140 - D 40 - H 35 CM
CAB96133-MO

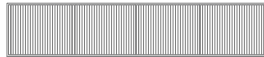

**TV CABINET RIBBLE HANGING
4 DOORS**
W 170 - D 40 - H 35 CM
CAB96134-MO

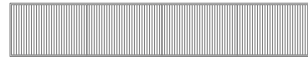

**TV CABINET RIBBLE HANGING
4 DOORS**
W 200 - D 40 - H 35 CM
CAB96169-MO

Wall

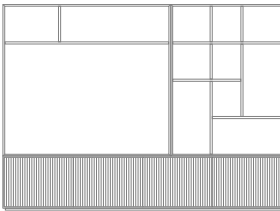

TV CABINET RIBBLE WALL
W 300 - D 40 - H 222 CM
CAB95698-MO



In de digitale wereld van vandaag hou je best rekening met de entertainment-behoefte van je huisgenoten. Haal je tv-ruimte daarom uit zijn standaard context door te kiezen voor een wandvullend meubel. Zo zorg je dat alles netjes wordt opgeborgen in plain sight en hou je het geheel clean en stijlvol.

In today's digital world, it's best to take your housemates' entertainment needs into account. So take your TV room out of its standard context by opting for a wall-filling unit. That way, you make sure everything is neatly stored in plain sight and keep the whole thing clean and stylish.



Standing / on feet

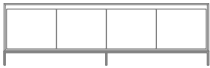

**TV CABINET VERSO 150
4 DOORS**
W 150 - D 40 - H 45 CM
CAB98144-MO



**TV CABINET VERSO 175
4 DOORS**
W 175 - D 40 - H 45 CM
CAB98145-MO



**TV CABINET VERSO 200
4 DOORS**
W 200 - D 40 - H 45 CM
CAB98146-MO

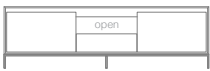

**TV CABINET VERSO 150
2 DOORS / 1 DRAWER**
W 150 - D 40 - H 45 CM
CAB98140-MO



**TV CABINET VERSO 175
2 DOORS / 1 DRAWER**
W 175 - D 40 - H 45 CM
CAB98141-MO



**TV CABINET VERSO 200
2 DOORS / 2 DRAWERS**
W 200 - D 40 - H 45 CM
CAB98142-MO

Standing / on soccle



**TV CABINET VERSO 150 - SOCCLE
4 DOORS**
W 150 - D 40 - H 45 CM
CAB95481-MO



**TV CABINET VERSO 175 - SOCCLE
4 DOORS**
W 175 - D 40 - H 45 CM
CAB95480-MO



**TV CABINET VERSO 200 - SOCCLE
4 DOORS**
W 200 - D 40 - H 45 CM
CAB95479-MO



**TV CABINET VERSO 150 - SOCCLE
2 DOORS / 1 DRAWER**
W 150 - D 40 - H 45 CM
CAB95478-MO



**TV CABINET VERSO 175 - SOCCLE
2 DOORS / 1 DRAWER**
W 175 - D 40 - H 45 CM
CAB95477-MO



**TV CABINET VERSO 200 - SOCCLE
2 DOORS / 2 DRAWERS**
W 200 - D 40 - H 45 CM
CAB95476-MO





Standing / hanging

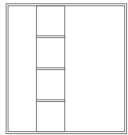

**CABINET VERSO HANGING
DOOR/OPEN/DOOR**
W 146 - D 35 - H 160 CM
CAB95535-MO

**PLINT/FOLDING DOWN DOOR
DOOR/OPEN/DOOR**
W 480 - D 40 - H 45 CM
CAB95671-MO

Hanging



**TV CABINET VERSO 150 HANGING
4 DOORS**
W 150 - D 40 - H 35 CM
CAB98136-MO



**TV CABINET VERSO 175 HANGING
4 DOORS**
W 175 - D 40 - H 35 CM
CAB98137-MO



**TV CABINET VERSO 200 HANGING
4 DOORS**
W 200 - D 40 - H 35 CM
CAB98138-MO



**TV CABINET VERSO 150 HANGING
2 DOORS / 1 DRAWER**
W 150 - D 40 - H 35 CM
CAB98132-MO



**TV CABINET VERSO 175 HANGING
2 DOORS / 1 DRAWER**
W 175 - D 40 - H 35 CM
CAB98133-MO



**TV CABINET VERSO 200 HANGING
2 DOORS / 2 DRAWERS**
W 200 - D 40 - H 35 CM
CAB98134-MO



Metro



Oak veneer

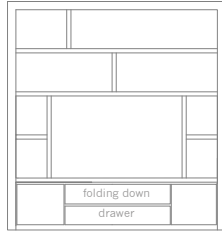

TV CABINET METRO 210 WALL
W 210 - D 45 - H 230 CM
CAB98995-RO

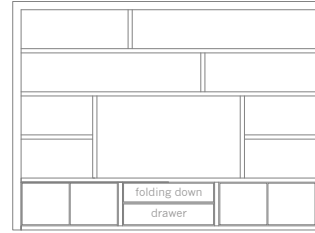

TV CABINET METRO 300 WALL
W 300 - D 45 - H 230 CM
CAB99235-RO



Lexon



Oak veneer



Standing

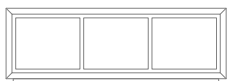

TV CABINET LEXON 150 3 DOORS
W 150 - D 40 - H 50 CM
CAB97856-MO

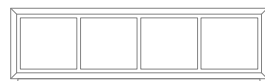

TV CABINET LEXON 175 4 DOORS
W 175 - D 40 - H 50 CM
CAB97858-MO



TV CABINET LEXON 200 4 DOORS
W 200 - D 40 - H 50 CM
CAB97860-MO



TV CABINET LEXON 150 OPEN / 2 DRAWERS
W 150 - D 40 - H 50 CM
CAB97855-MO



TV CABINET LEXON 175 OPEN / 3 DRAWERS
W 175 - D 40 - H 50 CM
CAB97857-MO



TV CABINET LEXON 200 OPEN / 3 DRAWERS
W 200 - D 40 - H 50 CM
CAB97859-MO

Hanging



TV CABINET LEXON 150 HANGING 3 DOORS
W 150 - D 40 - H 40 CM
CAB97578-MO



TV CABINET LEXON 175 HANGING 4 DOORS
W 175 - D 40 - H 40 CM
CAB97579-MO



TV CABINET LEXON 200 HANGING 4 DOORS
W 200 - D 40 - H 40 CM
CAB97580-MO

Maddox



Oak veneer



Standing



**TV CABINET MADDOX
4 DOORS**
W 150 - D 40 - H 50 CM
CAB97407-MO

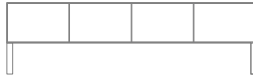

**TV CABINET MADDOX
4 DOORS**
W 175 - D 40 - H 50 CM
CAB97408-MO



**TV CABINET MADDOX
4 DOORS**
W 200 - D 40 - H 50 CM
CAB97468-MO

Hanging



**TV CABINET MADDOX HANGING
4 DOORS**
W 150 - D 40 - H 35 CM
CAB96878-MO



**TV CABINET MADDOX HANGING
4 DOORS**
W 175 - D 40 - H 35 CM
CAB96877-MO



**TV CABINET MADDOX HANGING
4 DOORS**
W 200 - D 40 - H 35 CM
CAB96876-MO

Dundee



Oak veneer

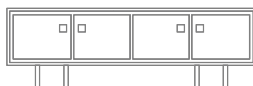

**TV CABINET DUNDEE 175
4 DOORS**
W 175 - D 40 - H 50 CM
CAB96872-MO

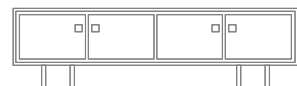

**TV CABINET DUNDEE 200
4 DOORS**
W 200 - D 40 - H 50 CM
CAB96873-MO

Scratches

Naast het zandstralen en borstelen, kan het hout ook met scratches bewerkt worden. Dit geeft een extra speels effect!

Sandblasted or brushed wood - or choose the scratched finish for an extra playful effect!

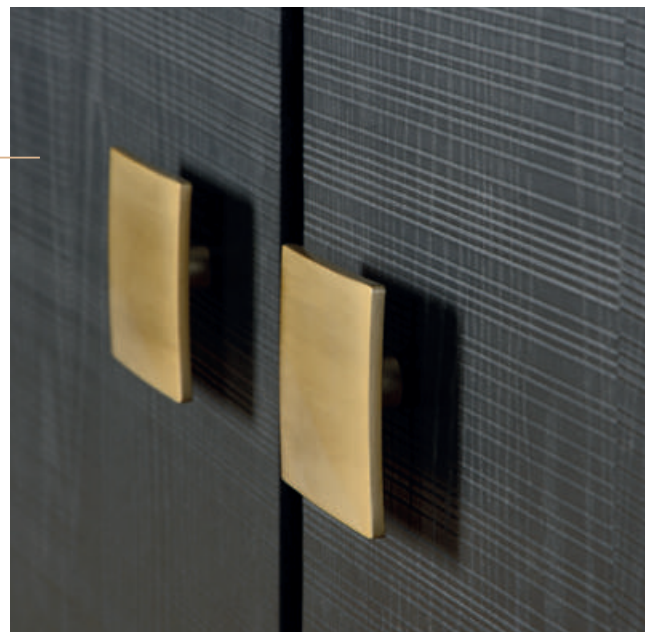



Moxy

Oak veneer



TV CABINET MOXY 180
2 DOORS / 2 DRAWERS
W 180 - D 40 - H 46 CM
CAB96868-MO



TV CABINET MOXY 210
2 DOORS / 2 DRAWERS
W 210 - D 40 - H 46 CM
CAB96856-MO



Bridge

Oak veneer / marble

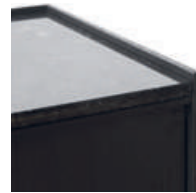

Standing



TV CABINET BRIDGE
4 DOORS
W 180 - D 40 - H 55 CM
CAB96129-MO



TV CABINET BRIDGE
4 DOORS
W 210 - D 40 - H 55 CM
CAB96130-MO

TV CABINET BRIDGE - MARBLE
4 DOORS
W 180 - D 40 - H 55 CM
CAB96127-MO

TV CABINET BRIDGE - MARBLE
4 DOORS
W 210 - D 40 - H 55 CM
CAB96128-MO

Hanging

Hanging version:
not possible with marble



TV CABINET BRIDGE HANGING
4 DOORS
W 180 - D 40 - H 40 CM
CAB96125-MO



TV CABINET BRIDGE HANGING
4 DOORS
W 210 - D 40 - H 40 CM
CAB96126-MO

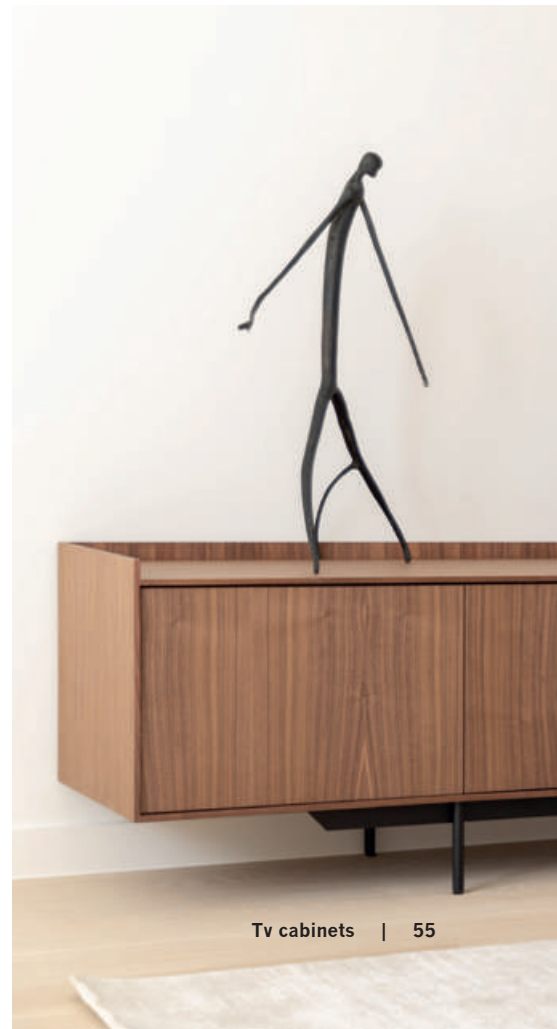

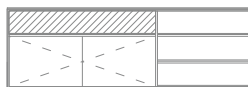

TV CABINET PLAZA
 W 150 - D 40 - H 65 CM CAB96595-RO
 W 175 - D 40 - H 65 CM CAB96596-RO
 W 200 - D 40 - H 65 CM CAB96723-RO



Ceci n'est pas un console

De Charrell meubels zijn ontworpen met een bepaalde bestemming voor ogen. Maar wat als nu net dat tv-meubel ideaal kan ingezet worden als console? Zolang de verhoudingen kloppen, is alles mogelijk!

Charrell furniture is designed with a particular purpose in mind. But what if just that TV furniture could be ideally used as a console? As long as the proportions are right, anything is possible!



Mezzo

Massive oak / oak veneer



Standing



**TV CABINET MEZZO 150
2 DOORS / 2 DRAWERS**
W 150 - D 40 - H 55 CM
CAB97868-RO



**TV CABINET MEZZO 180
2 DOORS / 2 DRAWERS**
W 180 - D 40 - H 55 CM
CAB97869-RO



**TV CABINET MEZZO 210
2 DOORS / 2 DRAWERS**
W 210 - D 40 - H 55 CM
CAB97870-RO

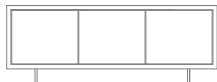

**TV CABINET MEZZO 150
3 DOORS**
W 150 - D 40 - H 55 CM
CAB97674-RO



**TV CABINET MEZZO 180
4 DOORS**
W 180 - D 40 - H 55 CM
CAB97676-RO

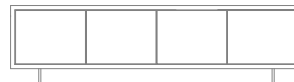

**TV CABINET MEZZO 210
4 DOORS**
W 210 - D 40 - H 55 CM
CAB97678-RO

Hanging



**TV CABINET MEZZO 150 HANGING
2 DOORS / 2 DRAWERS**
W 150 - D 40 - H 40 CM
CAB97679-RO



**TV CABINET MEZZO 180 HANGING
2 DOORS / 2 DRAWERS**
W 180 - D 40 - H 40 CM
CAB97680-RO



**TV CABINET MEZZO 210 HANGING
2 DOORS / 2 DRAWERS**
W 210 - D 40 - H 40 CM
CAB97681-RO



**TV CABINET MEZZO 150 HANGING
3 DOORS**
W 150 - D 40 - H 40 CM
CAB97673-RO



**TV CABINET MEZZO 180 HANGING
4 DOORS**
W 180 - D 40 - H 40 CM
CAB97675-RO



**TV CABINET MEZZO 210 HANGING
4 DOORS**
W 210 - D 40 - H 40 CM
CAB97677-RO

Tv cabinet Mezzo op maat,
met lijnen in de fronten
en op een sokkel.

Made to measure TV cabinet
Mezzo - with plinth and
lines in the fronts.



Tables & side furniture

Wanneer tafelen nóg aangenamer wordt en ook kleinere elementen het verschil kunnen maken. De essentie gekoppeld aan puur genot.

When dining becomes even more enjoyable and even smaller elements can make a difference. The essence combined with pure enjoyment.



Dining tables



Empire

H 76 CM
FH 72 CM



Oak veneer



W 240 - D 115 CM
W 260 - D 120 CM
W 280 - D 125 CM
W 300 - D 130 CM
W 350 - D 130 CM

TBL96689-RO
TBL96690-RO
TBL96691-RO
TBL96692-RO
TBL96501-RO



Kelby

H 76 CM
FH 72 CM



Oak veneer



ROUND

DIA 100 CM
DIA 120 CM
DIA 140 CM
DIA 150 CM

TBL95943-MO
TBL95944-MO
TBL96631-MO
TBL96634-MO

OVAL

W 180 - D 120 CM
W 200 - D 120 CM
W 220 - D 125 CM
W 240 - D 125 CM
W 260 - D 130 CM
W 280 - D 130 CM
W 300 - D 130 CM

TBL95542-MO
TBL95541-MO
TBL95540-MO
TBL95539-MO
TBL95538-MO
TBL95537-MO
TBL95536-MO



Simplicity

Een ronde tafel brengt rust in de ruimte en is erg praktisch. Deze dining table Kelby geeft comfortabel plaats aan verschillende tafelgasten zonder dat iemand last ondervindt van de poot.

A round table brings peace to the room and is very practical. This dining table Kelby comfortably seats several table guests without anyone being bothered by the leg.





Omer

H 75 CM
FH 71 CM



Massive oak



W 240 - D 115 CM
W 260 - D 115 CM
W 280 - D 115 CM
W 300 - D 125 CM
W 325 - D 125 CM

TBL95644-RO
TBL95645-RO
TBL95646-RO
TBL95647-RO
TBL95708-RO



Oase

H 76 CM
FH 72 CM



Massive oak



W 240 - D 110 CM
W 260 - D 110 CM
W 280 - D 110 CM
W 300 - D 110 CM
W 320 - D 110 CM

TBL95640-RO
TBL95641-RO
TBL95642-RO
TBL95643-RO
TBL95709-RO



Esra

H 75 CM
FH 72 CM



Massive oak



W 230 - D 130 CM
W 260 - D 140 CM
W 280 - D 150 CM

TBL95638-RO
TBL95703-RO
TBL95639-RO



Geïnspireerd door de natuur verwelkomen wij organische vormen in onze interieurs. Ronde vormen brengen rust en zijn toch speels en origineel. Onze eettafel Esra combineert het allemaal. De nieuwe trendkleur 'tobacco' geeft extra flair aan het ontwerp.

Inspired by nature we welcome organic shapes into our homes. Curves are comforting, playful and original. Our dining table Esra combines it all. The new trend colour 'tobacco' adds extra flair to the design.



Met zijn hoogte van 68 cm brengt de low dining table Erin een speelse en 'loungy' sfeer in je eetkamer. Met comfortabele low dining Glory stoelen eromheen kan je uren gezelligheid doorbrengen.

With its height of 68 cm, the low dining table Erin introduces playfulness and a 'loungy' ambiance into your dining room. With comfortable low dining Glory chairs around it, you can spend hours of conviviality.



Erin

H 68/75 CM
FH 65/72 CM



Oak veneer



W 230 - D 130 CM
W 260 - D 130 CM
W 280 - D 130 CM

TBL96922-RO
TBL96858-RO
TBL96857-RO



Nestor

H 76 CM
FH 72 CM



Massive oak / oak veneer



DIA 120 CM
DIA 130 CM
DIA 140 CM
DIA 150 CM
DIA 160 CM

TBL98208-RO
TBL98308-RO
TBL98302-RO
TBL98209-RO
TBL98210-RO



Spencer

H 76 CM
FH 72 CM



Massive oak / oak veneer



W 260 - D 123 CM
W 280 - D 123 CM
W 300 - D 130 CM

TBL97271-RO
TBL97272-RO
TBL97297-RO



Mona

H 76 CM
FH 72 CM



Oak veneer



OVAL
W 280 - D 123 CM
W 300 - D 130 CM

TBL97835-MO
TBL97836-MO

ROUND
DIA 130 CM
DIA 140 CM
DIA 150 CM
DIA 160 CM

TBL97651-MO
TBL97650-MO
TBL97649-MO
TBL97648-MO



Real

H 75 CM
FH 68 CM



Ceramic



RECTANGLE

W 160 - D 90 CM
W 190 - D 100 CM
W 240 - D 110 CM
W 280 - D 120 CM
W 320 - D 120 CM

TBL96750-CO
TBL96751-CO
TBL96752-CO
TBL95534-CO
TBL95533-CO

OVAL

W 240 - D 120 CM
W 280 - D 120 CM
W 320 - D 140 CM

TBL96747-CO
TBL96748-CO
TBL96749-CO



Barca

H 75 CM
FH 68 CM



Ceramic



W 190 - D 100 CM
W 240 - D 110 CM
W 280 - D 120 CM
W 320 - D 130 CM

TBL95532-CO
TBL95531-CO
TBL95907-CO
TBL95530-CO



Forza

H 75 CM
FH 68 CM



Ceramic



DIA 120 CM
DIA 140 CM
DIA 160 CM

TBL95524-CO
TBL95523-CO
TBL95522-CO



Madrid

H 75 CM
FH 68 CM



Ceramic



W 160 - D 130 CM
W 185 - D 140 CM
W 240 - D 110 CM
W 254 - D 140 CM
W 274 - D 119 CM
W 290 - D 140 CM
W 320 - D 140 CM

TBL95967-CO
TBL95529-CO
TBL95528-CO
TBL95527-CO
TBL95526-CO
TBL96562-CO
TBL95525-CO





Bekijk alle mogelijkheden van
de CO-keramische tafels bij
technische informatie p. 282

See all features of the CO
ceramic tables at Technical
information p. 282

Granvelle

H 76 CM
FH 73 CM



Walnut / ceramic



CERAMIC

W 260 - D 120 CM
W 280 - D 120 CM
W 300 - D 120 CM

TBL96394-IF
TBL96303-IF
TBL96395-IF

WOOD

W 260 - D 120 CM
W 280 - D 120 CM
W 300 - D 120 CM

TBL95952-IF
TBL95951-IF
TBL95950-IF



Tiny

H 76 CM
FH 73 CM



Walnut / ceramic



CERAMIC

DIA 100 CM
DIA 110 CM
DIA 120 CM
DIA 130 CM
DIA 140 CM

TBL96398-IF
TBL96399-IF
TBL96396-IF
TBL96397-IF
TBL96293-IF

WOOD

DIA 100 CM
DIA 110 CM
DIA 120 CM
DIA 130 CM
DIA 140 CM

TBL95949-IF
TBL95948-IF
TBL95947-IF
TBL95946-IF
TBL95945-IF



The details...

... are not the details!

De tafels uit de IF-collectie hebben een streepje voor als het op verfijning aankomt. Een eenvoudige poot ondersteunt het elegant vormgegeven blad, met- of zonder extra top in keramiek. (Deze bestaat dan weer in verschillende versies, mat of blinkend)

... are not the details!

The tables from the IF collection are distinctive in their refinement. A simple leg supports the elegantly styled tabletop, with or without additional ceramic top. (Available in various options, matt or gloss)





Cordoba

H 76 CM
FH 72 CM



Mortex



DIA 120 CM
DIA 130 CM
DIA 140 CM
DIA 150 CM
DIA 160 CM
DIA 180 CM

TBL95745-MO
TBL95744-MO
TBL95743-MO
TBL95873-MO
TBL95742-MO
TBL95741-MO



Marley

H 76 CM
FH 72 CM



Mortex



W 260 - D 120 CM
W 280 - D 125 CM
W 300 - D 130 CM

TBL95958-MO
TBL95739-MO
TBL95740-MO



Octa

H 76 CM
FH 72 CM



Mortex



W 260 - D 115 CM
W 280 - D 115 CM
W 300 - D 115 CM

TBL95554-MO
TBL95515-MO
TBL95514-MO



Campo

H 76 CM
FH 72 CM



Mortex



W 260 - D 155 CM

TBL95663-MO



Martin

H 76 CM
FH 72 CM



Massive oak / oak veneer



W 180 - D 90 CM
W 200 - D 100 CM
W 220 - D 100 CM
W 240 - D 100 CM
W 260 - D 100 CM
W 280 - D 110 CM

TBL97047-RO
TBL97046-RO
TBL97045-RO
TBL97151-RO
TBL97044-RO
TBL97043-RO



Palmer

H 76 CM
FH 71 CM



Massive oak / oak veneer



W 160 - D 90 CM
W 180 - D 90 CM
W 200 - D 100 CM
W 220 - D 100 CM
W 240 - D 100 CM
W 260 - D 100 CM

TBL98252-RO
TBL98253-RO
TBL98248-RO
TBL98249-RO
TBL98250-RO
TBL98251-RO



Iron & wood

De combinatie van hout met zwart metaal blijft een toppertje, ook als het gaat over eettafels. Metalen poten accentueren het natuurlijke karakter van het eiken blad.

The combination of wood and black metal stands the test of time, and this is also true for dining tables. Metal legs beautifully accentuate the natural tabletop.



Samber

H 76 CM
FH 72 CM



Massive oak / oak veneer



W 220 - D 100 CM
W 240 - D 100 CM
W 260 - D 100 CM

TBL98223-RO
TBL98422-RO
TBL98224-RO





Het massief eiken blad van de dining table Dorin is maar liefst 6 cm dik en komt het mooist tot zijn recht in een ruwere afwerking. Hier werd gekozen voor een 'rustic wood selection', opgevuld met mastiek.

The solid oak top of the dining table Dorin is a stunning 6 cm thick and looks best with a not-so-perfect finish. Here, we opted for a 'rustic wood selection', filled with putty.

Dorin

H 76 CM
FH 70 CM



Massive oak / oak veneer



W 220 - D 120 CM
W 240 - D 120 CM
W 260 - D 120 CM
W 280 - D 130 CM
W 300 - D 130 CM

TBL96314-RO
TBL96313-RO
TBL96366-RO
TBL96330-RO
TBL96329-RO



Woodland

H 76 CM
FH 72 CM



Massive oak / oak veneer



W 200 - D 100 CM
W 220 - D 100 CM
W 240 - D 100 CM
W 260 - D 100 CM
W 270 - D 100 CM
W 280 - D 110 CM
W 300 - D 110 CM

TBL97265-RO
TBL97266-RO
TBL97267-RO
TBL97268-RO
TBL97296-RO
TBL97269-RO
TBL96920-RO





Forrest

H 76 CM
FH 72 CM



Massive oak / oak veneer



W 200 - D 100 CM
W 220 - D 100 CM
W 240 - D 100 CM
W 260 - D 100 CM
W 280 - D 110 CM
W 300 - D 110 CM

TBL98235-RO
TBL98236-RO
TBL98427-RO
TBL98237-RO
TBL98238-RO
TBL98239-RO



Ferrum

H 76 CM
FH 69,5 CM



Massive oak / oak veneer



W 160 - D 90 CM
W 180 - D 90 CM
W 200 - D 100 CM
W 220 - D 100 CM
W 240 - D 100 CM
W 260 - D 100 CM

TBL98974-RO
TBL98973-RO
TBL98972-RO
TBL99044-RO
TBL99043-RO
TBL98753-RO





Wanneer je kiest voor een houten eettafel, kies je voor tijdloze klasse. De verschillende afwerkingen en bewerkingen maken je tafel helemaal 'af'. Vraag daarom raad aan onze medewerkers in onze conceptstore. A.d.h.v. diverse stalen en voorbeelden wordt het kiezen heel eenvoudig. Voor meer informatie, neem een kijkje op p. 4-11.

Choosing a wooden table means choosing a timeless classic. The various finishes and treatments are the extra touch to make your table unique. Please ask our staff in our conceptstore for advice. With our various samples and examples, it is easy to make the right choice. For more information, take a look at p. 4-11.

Zilton

H 76 CM
FH 71 CM



Massive oak / oak veneer

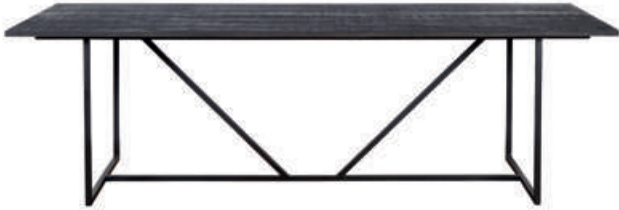

W 180 - D 90 CM
W 200 - D 100 CM
W 220 - D 100 CM
W 240 - D 100 CM
W 260 - D 100 CM
W 280 - D 110 CM
W 300 - D 110 CM

TBL97056-RO
TBL97055-RO
TBL97054-RO
TBL97053-RO
TBL97052-RO
TBL97051-RO
TBL97050-RO



May

H 76 CM
FH 71,5 CM



Oak veneer



W 180 - D 90 - H 76 - FH 71,5 CM
W 210 - D 100 - H 76 - FH 71,5 CM
W 230 - D 100 - H 76 - FH 71,5 CM
W 250 - D 100 - H 76 - FH 71,5 CM

TBL97244-RO
TBL97243-RO
TBL97242-RO
TBL97694-RO



Coffee tables





Zina

Oak veneer



S/2
 W 66 - D 60 - H 34 CM (SMALL) TBL96567-RO
 W 78 - D 70 - H 40 CM (MEDIUM)

W 78 - D 70 - H 34 CM (MEDIUM) TBL95966-RO
 W 105 - D 93 - H 40 CM (LARGE)



SINGLE
 W 66 - D 60 - H 34/40 CM (SMALL) TBL96509-RO
 W 78 - D 70 - H 34/40 CM (MEDIUM) TBL96508-RO
 W 105 - D 93 - H 34/40 CM (LARGE) TBL96507-RO



Todd

Oak veneer



S/2
 DIA 80 - H 44 CM TBL97075-RO
 DIA 60 - H 35 CM

DIA 90 - H 44 CM TBL97076-RO
 DIA 70 - H 35 CM

DIA 100 - H 44 CM TBL97077-RO
 DIA 80 - H 35 CM



SINGLE
 DIA 60 - H 35 CM TBL96855-RO
 DIA 70 - H 35 CM TBL96744-RO
 DIA 80 - H 35 CM TBL96854-RO
 DIA 90 - H 35 CM TBL96852-RO
 DIA 100 - H 35 CM TBL96853-RO



OPEN
 DIA 60 - H 44 CM TBL96895-RO
 DIA 80 - H 44 CM TBL96896-RO
 DIA 90 - H 44 CM TBL96848-RO
 DIA 100 - H 44 CM TBL96849-RO

COMBI WITH POUF RITZ



COMBO
 DIA 40 - H 35 CM TBL96895-RO+R40
 DIA 60 - H 35 CM TBL96896-RO+R60
 DIA 70 - H 35 CM TBL96848-RO+R70
 DIA 80 - H 35 CM TBL96849-RO+R80

Maddox

H 30 CM 

Oak veneer



RECTANGLE

W 120 - D 100 CM
W 140 - D 70 CM
W 150 - D 80 CM

TBL97692-MO
TBL97641-MO
TBL97640-MO

SQUARE

W 80 - D 80 CM
W 100 - D 100 CM
W 120 - D 120 CM

TBL97644-MO
TBL97643-MO
TBL97642-MO



Tripoti

H 34/44 CM 

Oak veneer



DIA 60 CM
DIA 70 CM
DIA 80 CM
DIA 90 CM
DIA 100 CM
DIA 110 CM
DIA 120 CM
DIA 130 CM

TBL95941-MO
TBL95940-MO
TBL96050-MO
TBL96049-MO
TBL96048-MO
TBL96047-MO
TBL95939-MO
TBL95938-MO



Drake

H 34/41 CM



Wood



DIA 50 CM
DIA 70 CM
DIA 80 CM
DIA 90 CM
DIA 100 CM
DIA 110 CM

TBL96122-MO
TBL96305-MO
TBL96121-MO
TBL96306-MO
TBL96120-MO
TBL96119-MO



Mix & match

De combinatie van verschillende materialen lijkt misschien wat gedurfd, maar niets is minder waar! Eens samengesteld, zijn ze onafscheidelijk. Vraag advies over de mogelijkheden.

The combination of various materials may seem risky, but just look at how it pays off. Once gathered, they are inseparable! Ask us about the possibilities.



Ascot

H 28/32 CM



Oak veneer / ceramic



DIA 90 CM
DIA 105 CM
DIA 120 CM

WOOD

TBL95660-MO
TBL95661-MO
TBL95662-MO

CERAMIC

TBL95659-MO
TBL95658-MO
TBL95657-MO



Axis

H 41 CM



Oak veneer



RECTANGLE

W 140 - D 70 CM
W 150 - D 80 CM
W 160 - D 80 CM
W 180 - D 90 CM
W 180 - D 60 - H 35 CM
W 200 - D 90 CM

TBL96564-RO
TBL96503-RO
TBL96566-RO
TBL96563-RO
TBL96582-MO
TBL96502-RO

SQUARE

W 80 - D 80 CM
W 100 - D 100 CM
W 110 - D 110 CM
W 120 - D 120 CM

TBL96506-RO
TBL96505-RO
TBL96565-RO
TBL96504-RO

ROUND

DIA 90 CM
DIA 110 CM
DIA 130 CM

TBL97065-RO
TBL97126-RO
TBL97064-RO





Oreta

H 30/32 CM



Oak veneer / ceramic top



DIA 90 CM
DIA 110 CM
DIA 130 CM

WOOD
TBL96039-MO
TBL96040-MO
TBL96069-MO

CERAMIC
TBL95674-MO
TBL95675-MO
TBL95676-MO



Cloud

H 35 CM



Oak veneer



DIA 80 CM
DIA 100 CM
DIA 110 CM
DIA 120 CM

TBL97220-MO
TBL97219-MO
TBL97218-MO
TBL97217-MO





Asra

H 30 CM



Oak veneer



RECTANGLE

W 150 D 61 CM
W 170 D 61 CM

TBL96327-RO
TBL96326-RO

SQUARE

W 100 D 100 CM

TBL96328-RO

ROUND

DIA 100 CM

TBL96365-RO



Rhana

H 35 CM



Oak veneer



W 140 - D 70 CM
W 160 - D 80 CM
W 180 - D 90 CM

TBL95632-RO
TBL95633-RO
TBL95704-RO



Chivas

H 35 CM



Oak veneer



RECTANGLE

W 160 - D 80 CM

TBL95651-MO

SQUARE

W 80 - D 80 CM
W 100 - D 100 CM
W 120 - D 120 CM

TBL95648-MO
TBL95649-MO
TBL95650-MO





Presso

H 35 CM



Mortex



W 140 - D 80 CM
W 160 - D 80 CM

TBL95521-MO
TBL95543-MO



Steff

H 35 / 45 / 55 CM



Mortex



DIA 70 CM
DIA 80 CM
DIA 90 CM
DIA 100 CM
DIA 110 CM
DIA 120 CM
DIA 130 CM

TBL95875-MO
TBL95737-MO
TBL95736-MO
TBL95735-MO
TBL95734-MO
TBL95733-MO
TBL95732-MO



Contrasting textures

Dankzij het handmatige aanbrengen van mortex ontstaan er unieke texturen. Dit resulteert in een half-mat oppervlak, dat hier mooi contrasteert met het tapijt.

The manual application of mortex creates unique textures. This results in a semi-matt surface, which contrasts nicely with the carpet here.



Twist

H 38 CM



Oak veneer / marble



WOOD

DIA 80 CM
DIA 100 CM
DIA 120 CM

TBL97647-MO
TBL97646-MO
TBL97645-MO

MARBLE

DIA 80 CM
DIA 100 CM
DIA 120 CM

TBL97867-MO
TBL97866-MO
TBL97865-MO



Marmar is een natuursteen, dat door geologische processen eeuwenlang werd 'geboetseerd'. Elk blad is hierdoor anders en uniek. Het intrigerende spel van kleuren en adering is dé troef van marmar.

Marble is a natural stone, which has been 'sculpted' over centuries by geological processes. As a result, each sheet is different and unique. The intriguing play of colours and veining is marble's trump card.



Uma

H 35 CM



Oak veneer / travertine



TRAVERTINE

DIA 90 CM
DIA 110 CM
DIA 130 CM

TBL95697-MO
TBL95696-MO
TBL95695-MO

WOOD

DIA 90 CM
DIA 110 CM
DIA 130 CM

TBL95694-MO
TBL95693-MO
TBL95692-MO



Gerono

H 38 CM



Marble



W 140 - D 97

TBL95954-RO



Hier werd gewerkt met het marmar 'Silvero Silver'

Hier werd gewerkt met het marmar 'Silvero Silver'





Plaza

H 36 CM



Oak veneer



RECTANGLE

W 140 - D 80 CM
W 150 - D 80 CM
W 160 - D 80 CM

TBL96639-RO
TBL96638-RO
TBL96637-RO

SQUARE

W 90 - D 90 CM
W 100 - D 100 CM
W 110 - D 110 CM
W 120 - D 120 CM

TBL96642-RO
TBL96641-RO
TBL96728-RO
TBL96640-RO



Flinn

H 38 CM



Oak veneer



2 DRAWERS / OPEN RECTANGLE

W 140 - D 70 CM
W 150 - D 80 CM

CAB97395-MO
CAB97396-MO

2 DRAWERS / OPEN SQUARE

W 80 - D 80 CM
W 100 - D 100 CM
W 120 - D 120 CM

CAB97253-MO
CAB97252-MO
CAB97251-MO





Ferrum 2x2 cm

Massive oak / oak veneer



SINGLE RECTANGLE

W 120 - D 70 CM
W 140 - D 70 CM
W 150 - D 80 CM
W 160 - D 80 CM
W 180 - D 80 CM

TBL98964-RO
TBL98963-RO
TBL98962-RO
TBL98961-RO
TBL98960-RO

SINGLE SQUARE

W 80 - D 80 CM
W 100 - D 100 CM
W 120 - D 120 CM

TBL98959-RO
TBL98958-RO
TBL98957-RO



DOUBLE RECTANGLE

W 120 - D 70 CM
W 140 - D 70 CM
W 150 - D 80 CM
W 160 - D 80 CM
W 180 - D 80 CM

TBL98971-RO
TBL99138-RO
TBL98970-RO
TBL98969-RO
TBL98968-RO

DOUBLE SQUARE

W 80 - D 80 CM
W 100 - D 100 CM
W 120 - D 120 CM

TBL98967-RO
TBL98966-RO
TBL98965-RO



S/2

W 70 - D 70 - H 38 CM
W 60 - D 60 - H 30 CM
W 90 - D 90 - H 38 CM
W 80 - D 80 - H 30 CM

TBL97355-RO

TBL97030-RO



Ferrum Fine 1x1 cm



Oak veneer



RECTANGLE

W 140 - D 40 CM
W 150 - D 40 CM
W 160 - D 40 CM

TBL98362-RO
TBL97750-RO
TBL98200-RO



Consoles





Hawk

Oak veneer



W 160 - D 50 - H 70 CM TBL95654-MO
W 180 - D 50 - H 70 CM TBL95655-MO
W 200 - D 50 - H 70 CM TBL95656-MO



Berry

Oak veneer



W 180 - D 45 - H 62 CM TBL95636-RO
W 200 - D 45 - H 62 CM TBL95705-RO
W 220 - D 45 - H 62 CM TBL95637-RO





Style your corner

Groeppeer verschillende meubels en laat ze elkaar overlappen. Dit creëert niet alleen diepte en eenheid, maar voegt ook kracht toe aan het interieur. Deze console La Toya krijgt extra body dankzij de seat Tommy, die op de voorgrond staat.

Group several pieces of furniture together and let them overlap. This not only creates depth and unity, but also adds strength to the interior. This console La Toya gets extra body thanks to the seat Tommy, which is in the foreground.

La Toya



Oak veneer



W 208 - D 45 - H 80 CM

TBL95653-MO



Ranger



Oak veneer



W 160 - D 40 - H 60 CM TBL95668-MO
W 180 - D 40 - H 60 CM TBL95669-MO
W 200 - D 40 - H 60 CM TBL95670-MO



Regale



Oak veneer



W 160 - D 45 - H 75 CM TBL95679-MO
W 180 - D 45 - H 75 CM TBL95680-MO
W 200 - D 45 - H 75 CM TBL95681-MO



Niko



Oak veneer



W 140 - D 50 - H 64 CM
W 160 - D 50 - H 64 CM
W 180 - D 50 - H 64 CM
W 200 - D 50 - H 64 CM

TBL96043-MO
TBL96044-MO
TBL96070-MO
TBL96045-MO





Dexter

Oak veneer



1 DRAWER

W 140 - D 35 - H 76 CM

TBL97469-MO

W 160 - D 35 - H 76 CM

TBL97410-MO

W 180 - D 35 - H 76 CM

TBL97473-MO



Blake

Oak veneer



W 140 - D 35 - H 75 CM

TBL97022-MO

W 160 - D 35 - H 75 CM

TBL97021-MO

W 180 - D 35 - H 75 CM

TBL97020-MO

W 200 - D 35 - H 75 CM

TBL97019-MO



Graag zetten we onze console Dexter in de kijker. Gewoon... omdat hij zo mooi én handig is! Dankzij de lade heb je meteen een opbergplek voor kleine spulletjes.

Let's put the spotlight on our console Dexter. No particular reason, other than that it's both marvellous and useful! The drawer ensures small items can be stored out of sight.







Ferrum 2x2 cm

Massive oak / oak veneer



W 120 - D 40 - H 75 CM	TBL98956-RO
W 140 - D 40 - H 75 CM	TBL98955-RO
W 160 - D 40 - H 75 CM	TBL99045-RO
W 180 - D 40 - H 75 CM	TBL98954-RO
W 200 - D 40 - H 75 CM	TBL98953-RO



OPEN 15

W 140 - D 40 - H 75 CM	TBL97235-RO
W 160 - D 40 - H 75 CM	TBL97236-RO
W 180 - D 40 - H 75 CM	TBL97237-RO
W 200 - D 40 - H 75 CM	TBL97365-RO

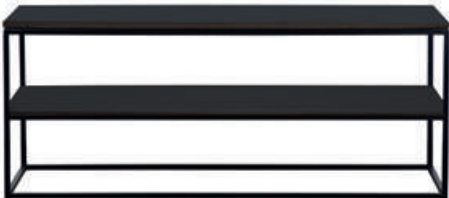

LOW

W 160 - D 50 - H 65 CM	TBL98952-RO
W 180 - D 50 - H 65 CM	TBL98951-RO
W 200 - D 50 - H 65 CM	TBL98950-RO

Ferrum Fine 1x1 cm



Oak veneer



W 160 - D 40 - H 75 CM	TBL98613-RO
W 180 - D 40 - H 75 CM	TBL98614-RO



Een console is een ideale toevoeging om een minder interessante plek in de ruimte wat meer in de kijker te zetten. Mits een goede styling met persoonlijke items, deco en/of verlichting zorg je voor dat gevoel van echt thuis komen.

A console is an ideal addition to highlight a less interesting spot in the room. Great styling with personal and decorative items and/or lighting ensures you feel welcome when you come home.



Flinn



Oak veneer



3 DRAWERS / 1 SHELF

W 150 - D 35 - H 65 CM
W 175 - D 35 - H 65 CM
W 200 - D 35 - H 65 CM

TBL97264-MO
TBL97493-MO
TBL97394-MO



1D/2DR

W 140 - D 40 - H 77 CM
W 160 - D 40 - H 77 CM
W 180 - D 40 - H 77 CM

TBL95547-MO
TBL95548-MO
TBL95776-MO



OPEN

W 120 - D 35 - H 75 CM
W 140 - D 35 - H 75 CM
W 160 - D 35 - H 75 CM
W 180 - D 35 - H 75 CM
W 200 - D 35 - H 75 CM

TBL97261-MO
TBL97262-MO
TBL97263-MO
TBL97492-MO
TBL97389-MO



HIGHLOW

W 180 - D 35 - H 75 CM
W 210 - D 35 - H 75 CM
W 240 - D 35 - H 75 CM

TBL95634-MO
TBL95635-MO
TBL95707-MO





Madison

Oak veneer / marble



WOOD

W 160 - D 35 - H 75 CM
W 180 - D 35 - H 75 CM
W 200 - D 35 - H 75 CM

TBL97636-MO
TBL97635-MO
TBL97634-MO

MARBLE

W 160 - D 35 - H 75 CM
W 180 - D 35 - H 75 CM
W 200 - D 35 - H 75 CM

TBL97638-MO
TBL97904-MO
TBL97637-MO



Trix



Oak veneer



W 120 - D 40 - H 75 CM TBL97277-MO
W 140 - D 40 - H 75 CM TBL97276-MO
W 160 - D 40 - H 75 CM TBL97275-MO
W 180 - D 40 - H 75 CM TBL97274-MO





Perfect together

Combineer de console Metro met een cube Charlie voor extra sfeer en gezelligheid! Het staat mooi, en tegelijk berg je zo een extra zitje op dat je kan bijschuiven.

Combine the console Metro table with the cube Charlie for extra ambiance and cosiness. A beautiful look as well as an extra seat that easliy hides away.

Metro



Oak veneer



OPEN

W 150 - D 50 - H 85 CM
W 180 - D 50 - H 85 CM

TBL99231-RO
TBL98977-RO



2 DRAWERS

W 140 - D 50 - H 76 CM
W 160 - D 50 - H 76 CM

TBL99230-RO
TBL98978-RO

Side tables



Flinn

H 38 CM



Oak veneer



1 DRAWER
W 60 - D 60 - H 45 CM TBL97273-MO
W 70 - D 70 - H 45 CM TBL97491-MO





Ferrum 2x2 cm

Massive oak / oak veneer



W 55 - D 55 - H 45 CM
TBL99137-RO



S/2
W 50 - D 50 - H 50 CM
W 40 - D 40 - H 40 CM
TBL98099-RO



Ferrum Fine 1x1 cm

Oak veneer



S/2
W 50 - D 50 - H 50 CM
W 40 - D 40 - H 40 CM
TBL98291-RO

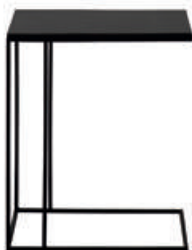

SIDE TABLE FERRUM HOLDER
W 35 - D 50 - H 55 CM
TBL98651-RO

Het summum van relaxen: niet te ver moeten reiken naar een boekje en een drankje... Alles binnen handbereik!

The ultimate in relaxation: not having to reach too far for a book and a drink... Everything within easy reach!



Trix



Oak veneer



W 60 - D 40 - H 45 CM
TBL97132-MO



It takes two

Een set van twee bijzettafels staat altijd mooi naast een sofa of seat. Ze vormen samen een kluster en zorgen voor wat pit in het geheel. Ook een leuk effect bekom je wanneer je één of twee tafeltjes combineert met een pouf.

A set of two side tables always looks good next to a sofa or chair. The result is a cluster that brings some spice to the room. Or combine one or two tables with a pouf for a very effective result.

Cloud



Oak veneer



S/2
DIA 60 - H 53 CM
DIA 40 - H 46 CM

TBL97464-MO



Duo



Oak veneer



S/2
W 50 - D 50 - H 45 CM
W 43 - D 43 - H 38 CM

TBL97486-RO





Elouise



Oak veneer



DIA 45 - H 48 CM

TBL95706-RO





Kleuren maken je vrolijk, en al zeker wanneer ze je huiskamer binnen komen. De gelakte bijzettafeltjes Ziggy kunnen gemaakt worden in elke RAL kleur naar wens.

Colours make you happy, especially when they enter your living room. The lacquered side tables Ziggy can be made in any RAL colour of your choice.

Ziggy



Laquered



DIA 60 - H 55 CM

TBL95683-MO



Donovan



Oak veneer



DIA 45 - H 50 CM

TBL95667-MO



Tripoti



Oak veneer



DIA 60 - H 53 CM
TBL96051-MO



Mauro



Oak veneer



WOOD
DIA 60 - H 45 CM TBL95953-MO

MARBLE
DIA 60 - H 45 CM TBL96635-MO



Bill



Mortex



DIA 45 - H 45 CM TBL95955-MO



Uma



Oak veneer



DIA 45 - H 45/55 CM
DIA 60 - H 45/55 CM

WOOD
TBL95689-MO
TBL95688-MO

TRAVERTINE
TBL95690-MO
TBL95691-MO





Sofa side
furniture





CUBE LEXON CLOSED
W 50 - D 95 - H 50 CM
TBL96925-MO



CUBE LEXON OPEN
W 50 - D 95 - H 50 CM
TBL95550-MO



CUBE LEXON SHELF
W 50 - D 95 - H 50 CM
TBL95962-MO

De cube Lexon is een must-have om van je sofa iets unieks te maken. De sofa wordt als het ware onderboken door een pittige side table. Dit element gaat naadloos op in het geheel omdat het op maat én in de kleur van jouw keuze wordt gemaakt.

The cube Lexon is a must-have for turning your sofa into something unique. The sofa is, as it were, undercut by a spirited side table. This element blends in seamlessly as it is made to measure and in the colour of your choice.





Sofa side table Lexon - long

Side by side

De side tables Lexon zijn ideaal om je zithoek meer flair te geven. Plaats een sofa side table achter de sofa, of zorg voor een onderbreking tussen verschillende zitelementen met de cube.

The side tables Lexon are ideal for jazzing up your sitting room. Place a sofa side table behind the sofa, or use a cube to accentuate the various seating elements.



SOFA SIDE TABLE LEXON - DECO
W 220 - D 45 - H 60 CM
TBL97703-MO

SOFA SIDE TABLE LEXON - LONG
W 190 - D 40 - H 35 CM
TBL96636-MO



SOFA SIDE TABLE LEXON - DESK
W 280 - D 45 - H 60 CM
TBL97704-MO

Pico



Oak veneer



SOFA SIDE TABLE PICO
W 123 - D 45 - H 38 CM
TBL95652-MO



Stands



Trix



Oak veneer



STAND TRIX

W 45 - D 45 - H 95 CM

W 50 - D 30 - H 95 CM

W 70 - D 40 - H 95 CM

TBL97259-MO

TBL97484-MO

TBL97258-MO



Ferrum 2x2 cm



Massive oak / oak veneer



STAND FERRUM

W 30 - D 30 - H 70 CM

W 30 - D 30 - H 85 CM

TBL98949-RO

TBL98948-RO



In the picture

Een stand geeft basis aan eender welk object dat je erop plaatst. Of het nu gaat over een beeldhouwwerk, een souvenir of een mooie vaas, het komt vast geen aandacht tekort!

A stand elevates any object you choose to display. Whether it is a sculpture, a souvenir, or a beautiful vase, it will draw adoring eyes!

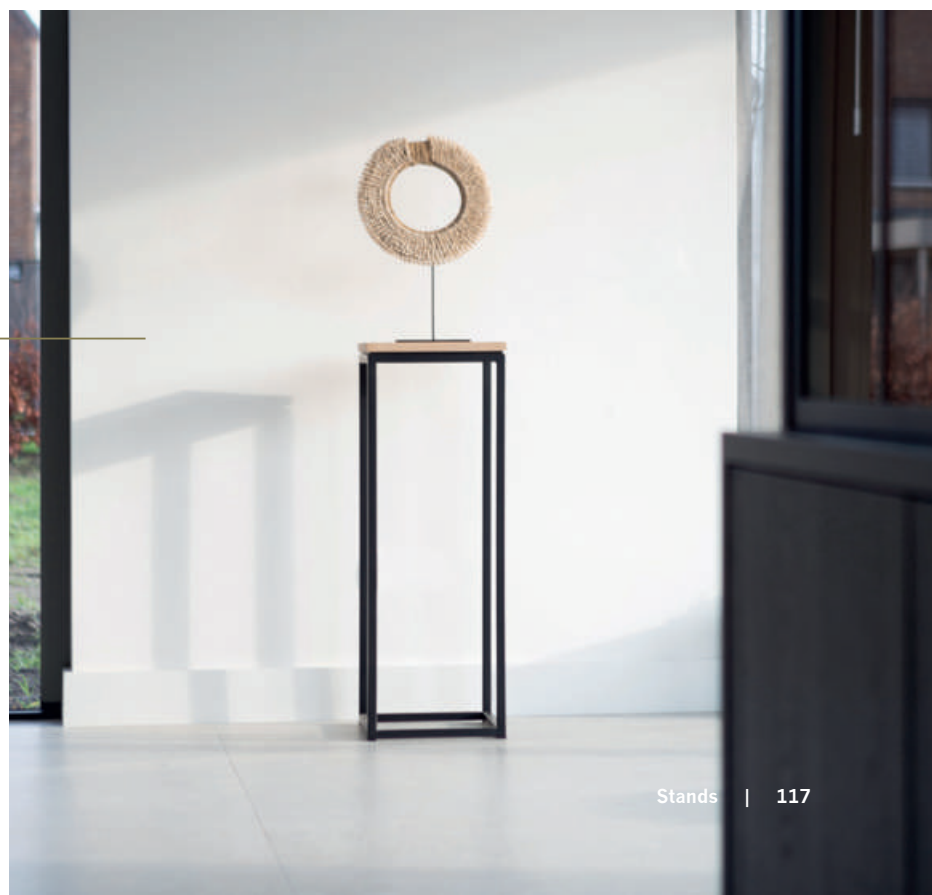

Desks



Yankee

H 76 CM
FH 73 CM



Walnut



WOOD

W 180 - D 100 CM
W 200 - D 100 CM
W 220 - D 100 CM
W 240 - D 100 CM

TBL96214-IF
TBL96302-IF
TBL96213-IF
TBL96212-IF

WOOD + CERAMIC TOP

W 180 - D 100 CM
W 200 - D 100 CM
W 220 - D 100 CM
W 240 - D 100 CM

TBL96211-IF
TBL96210-IF
TBL96209-IF
TBL96208-IF



Camy

H 77 CM
FH 75 CM



Oak veneer



W 120 - D 70 - H 79 CM
W 140 - D 70 - H 79 CM

TBL95684-MO
TBL95685-MO



Ferrum

H 77 CM
FH 72 CM



Massive oak / oak veneer



W 140 - D 60 CM
W 170 - D 80 CM
W 200 - D 90 CM

TBL98918-RO
TBL98917-RO
TBL98916-RO



Homework

Werken in een thuisomgeving is meer dan realiteit geworden. Mits de juiste vormgeving van de ruimte en een goed doordachte keuze qua meubels, wordt een aangename work-life balance thuis een feit!

Working in a home environment has become more than reality. With the right layout and style in your space, and well-considered furniture choices, you can achieve a pleasant work-life balance in your home!

H 76 CM
FH 61 CM



Oak veneer



2 DRAWERS
W 140 - D 65 CM
W 160 - D 65 CM
W 180 - D 65 CM

TBL97970-RO
TBL95937-RO
TBL95936-RO



Masha

H 75 CM
FH 67 CM



Oak veneer



W 160 - D 60 CM
W 180 - D 60 CM
W 200 - D 60 CM

TBL96041-MO
TBL96066-MO
TBL96042-MO



Vigo

H 86 CM
FH 73 CM



Oak veneer



W 140 - D 65 CM
W 170 - D 65 CM
W 200 - D 65 CM
W 240 - D 65 CM

TBL97280-RO
TBL97279-RO
TBL97278-RO
TBL97481-RO



Metro

H 77 CM
FH 72 CM



Oak veneer



W 140 - D 75 CM
W 170 - D 80 CM
W 200 - D 90 CM

TBL98976-RO
TBL99223-RO
TBL98975-RO



DRAWER UNIT METRO
W 45 - D 55 - H 60 CM
CAB99041-RO



Onze collectie desks kreeg er twee toppers bij met deze unieke hangende wandmeubelen. De ruimtelijkheid wordt behouden terwijl het meubel één wordt met de ruimte en duidelijk structuur toevoegt.

Our desks collection gained two toppers with these unique hanging wall units. The spaciousness is maintained while the furniture becomes one with the room and clearly adds structure.

Gobi

H 76 CM
FH 71 CM



Oak veneer



WALL DESK GOBI HANGING
W 220 - D 58 - H 125 CM TBL96067-MO

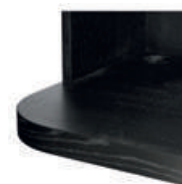

Caspian

H 77 CM
FH 69 CM



Oak veneer



DESK CASPIAN HANGING
W 240 - D 58 CM - H 128 CM TBL95666-MO



Night tables





Ferrum

Oak veneer



1 DRAWER
W 50 - D 40 - H 55 CM
TBL98363-RO



Flinter



Oak veneer



OPEN
W 50 - D 40 - H 55 CM
TBL97392-RO



Chairs

Gereserveerd voor je 'inner circle'. Adem.
Maak ruimte voor wat echt telt. De ware betekenis
van thuiskomen.

Reserved for your 'inner circle'. Breathe.
Make space for what really matters. The true meaning
of coming home.



Dining chairs



Naast comfort mag een stoel best wel de nodige flair hebben. Een eettafel komt pas echt tot leven wanneer de stoelen eromd zorgvuldig zijn uitgekozen qua vorm en bekleding.

A chair should be comfortable and add some flair. A dining table really stands out when the chairs around are carefully selected for their shape and upholstery.



Armchair Enrica



W 54 - D 59 - H 84 CM CHR96740
HS 48 - HA 68 CM



Armchair Amelia



W 59 - D 62 - H 85 CM CHR95557
HS 48 - HA 71 CM



Armchair Lucca



W 56 - D 57 - H 75 CM CHR96402
HS 47 - HA 66 CM





Armchair Verbier

W 55 - D 57 - H 80 CM CHR96741
HS 48 CM - HA 66



Chair Verbier

W 55 - D 57 - H 80 CM CHR96742
HS 48 CM



Armchair Jazz

W 55 - D 57 - H 80 CM CHR96054
HS 48 CM - HA 66



Armchair Monti



Armchair Casino



Chair Denver



CHR96373



Armchair Allure



CHR96371



Armchair Molto



CHR96374

Eenvoud siert! De 'minimal trend' is nog steeds upcoming en is veel breder toepasbaar dan de reeds langer populaire Scandinavische woonstijl.

De massief houten stoelen zijn mooi te combineren met materialen als keramiek, marmer, microtopping of hout.

Simplicity rules! The 'minimalism' trend is still a rising star, and much more versatile than the Scandi style that has been popular for some time.

The solid wood chairs are easy to combine with materials such as ceramics, marble, Microtopping, or wood.



Chair Harmo



W 51 - D 49 - H 80 CM CHR96699
HS 47 CM
WOOD



Chair Trudo



W 50 - D 51 - H 74 CM CHR96118
HS 47 CM
WOOD / LEATHER



Chair Madalena



W 60 - D 57 - H 86 CM CHR95788
HS 49 CM





Chair Lucy

W 47 - D 60 - H 87 CM CHR97523



Chair Rico

W 50 - D 63 - H 90 CM CHR98360



Chair Antonio

W 48 - D 53 - H 82 CM CHR98109





Armchair Antonio

W 61 - D 59 - H 81 CM CHR98108



Armchair Delfino

W 65 - D 60 - H 79 CM CHR96152



Armchair Yumae

W 65 - D 60 - H 83 CM CHR96153





Chair Sitka



W 51 - D 55 - H 78 CM CHR97685
HS 46 CM



Armchair Odo



W 58 - D 58 - H 78 CM CHR97686
HS 46 - HA 64 CM

Poly practical

Nieuw in ons gamma zijn de stoelen vervaardigd uit polypropyleen. Ze matchen perfect bij eender welke tafel en zijn in verschillende kleuren beschikbaar, met- of zonder zitkussen.

The chairs made from polypropylene are new additions to our range. They are a perfect match with any table and available in a selection of colours, with or without seat pad.



Armchair Sicla



W 59 - D 53 - H 80 CM CHR96696
HS 45 - HA 67 CM
POLYPROPYLENE





Stoelen in kunstleder zijn een onderhoudsvriendelijk en voordelig alternatief op stoelen met een echte lederen bekleding. Dankzij de mooie imitatie kan je de lederlook integreren in je interieur.

Faux leather chairs are a low-maintenance and low-cost alternative to chairs with real leather covers. The great quality imitation leather is a good way to introduce the leather look to your interior.



Armchair Viking



W 61 - D 61 - H 80 CM CHR97147

PU LEATHER



Chair Viking



W 51 - D 60 - H 79 CM CHR98530

PU LEATHER



Chair Flint



W 45 - D 57 - H 82 CM CHR97995

PU LEATHER
TURNING

Counter chairs





Chair Dylan counter



W 43 - D 52 - H 92 CM CHR97591
HS 65 CM
PU LEATHER



Chair Flint counter



W 43 - D 48,5 - H 89,5 CM CHR97996
HS 65 CM
PU LEATHER



Chair Urban counter



W 44 - D 55 - H 95 CM CHR97135
HS 67 CM
PU LEATHER



Chair Viking counter



W 50 - D 51 - H 91 CM CHR97145
HS 65 CM
PU LEATHER



Chair Pello counter



W 45 - D 36 - H 73 CM CHR96164
HS 73 CM
REAL LEATHER



Chair Harmo counter

W 40 - D 46 - H 90 CM CHR96698
HS 65 CM
WOOD



Chair Rico counter

W 49 - D 59 - H 97 CM CHR97720
HS 67 CM



Chair Pure Loop mono kitchen

W 47 - D 53 - H 101 CM CHR96193
HS 66 CM
POLYPROPYLENE



Seats & sofas

Waar de omgeving net die sfeer uitstraalt om van je huis een thuis te maken. Meubels die je laten zijn wie je bent, op welk moment dan ook.

Where the setting exudes just that atmosphere to make your house a home. Furniture that allows you to be who you are, at any time.



Seats





Seat Aude

W 73 - D 70 - H 73 CM
HS 43 CM CHR96992



Seat Mobi

W 75 - D 83 - H 81 CM
HS 42 CM CHR96322



Seat Glory

W 62 - D 52 - H 75 CM CHR95513



Colour boost

Wanneer je een manier zoekt om stijlvol en subtiel een streepje kleur toe te voegen aan je interieur, is een fauteuil of clubzetel een slim idee! In dit project werd gekozen om de boventoon zacht en licht te houden. Als prachtige eye-catcher koos de klant voor de seat Glory in roestbruin velvet.

When looking for a way to classy and subtile add a touch of colour to your interior, an armchair or club chair is a smart idea! In this project, the choice was made to keep the overtone soft and light. As a beautiful eye-catcher, the client chose the seat Glory in rust brown velvet.



Seat Felix

W 65 - D 67 - H 69 CM CHR96894
HS 43 CM



Seat Ipswich

W 82 - D 80 - H 84 CM CHR95512





Seat Olivia

W 79 - D 75 - H 80 CM CHR96885





Seat Tommy



W 75 - D 80 - H 74 CM CHR95764



Seat Cullot



W 65 - D 70 - H 69 CM CHR95872



Seat Kozy



W 67 - D 72 - H 74 CM CHR96569







Seat Gaetan

W 83 - D 95 - H 89 CM CHR96101



Seat Odin

W 70 - D 82 - H 84 CM CHR95765





Seat Aleto

W 83 - D 83 - H 74 CM CHR96444



Info on p. 229



Seat Dean

W 68 - D 76 - H 76 CM CHR95711





Seat Bossu

W 77 - D 77 - H 73 CM CHR96117



Seat Grino

W 74 - D 80 - H 72 CM CHR96237





Seat Lovat



W 77 - D 90 - H 69 CM
HS 38 CM CHR95868



Seat Celeste



W 60 - D 60 - H 59 CM
HS 39 CM CHR95881



Seat los



W 80 - D 80 - H 73 CM CHR97228







Thuis willen we in de eerste plaats tot rust komen en een gezellige cocon creëren. Door ronde vormen te integreren in je interieur, breek je de veelal architecturale rechte lijnen en zorg je voor een speelse touch. Een ronde bijzetzetel in een heerlijk luxueuze stof geeft je instant dat warme thuisgevoel...

At home, we primarily want to unwind and create a cosy cocoon. By integrating round shapes into your interior, you break up the mostly architectural straight lines and add a playful touch. A round side chair in a wonderfully luxurious fabric gives you that warm home feeling instantly...



Comfy lounge small

W 114 - D 110 - H 89 CM CHR95510

Comfy lounge XL

W 134 - D 130 - H 89 CM CHR95509

Comfy pouf

DIA 70 - H 46 CM CHR95508
 DIA 90 - H 46 CM CHR95507
 DIA 110 - H 46 CM CHR95506





Sofa Romy



W 135 - D 135 - H 65 CM CHR95505



Sofa Rondo



W 155 - D 155 - H 85 CM CHR95605





Fauteuil Quartz

W 79 - D 94 - H 115 CM CHR95504

Make yourself comfortable

Na inspanning komt ontspanning. Een stoel van leder voor een stoere uitstraling, of liever een zachte stoel van velvet? Dankzij de verschillende kleuren en mogelijkheden kies je jouw ideale partner in relaxen!

After exertion comes relaxation. A chair made of leather for a tough look, or rather a soft chair made of velvet? Thanks to the different colours and options, choose your ideal partner in relaxation!





Fauteuil Rousseau

W 90 - D 90 - H 100 CM CHR95503



Fauteuil Luxor

W 87 - D 80 - H 95 CM CHR95502



Fauteuil Lois

W 93 - D 84 - H 96 CM CHR95501



A pouf is always a good idea

Net op dat ene plekje in de keuken, op de kinderkamer of in combinatie met je salontafel. Een pouf is een onmisbaar element in huis. Gebruik hem als voetenbank op een luie zondagmiddag. Heb je mensen over de vloer? Gebruik de pouf dan bijvoorbeeld als bijzettafel of extra zitplek.

Just in that one spot in the kitchen, in the children's room or in combination with your coffee table. A pouf is an indispensable element in your home. Use it as an ottoman on a lazy Sunday afternoon. Do you have people over? Then you could use the pouf as a side table or an extra seat.



Pouf Ritz

DIA 40 - H 30/35 CM
DIA 60 - H 30/35 CM
DIA 70 - H 30/35 CM
DIA 80 - H 30/35 CM
DIA 90 - H 30/35 CM
DIA 45 - H 45 CM

CHR96828
CHR96773
CHR96804
CHR96827
CHR96733
CHR96774



Pouf Mia

DIA 40 - H 30/35 CM
DIA 60 - H 30/35 CM
DIA 70 - H 30/35 CM
DIA 80 - H 30/35 CM
DIA 90 - H 30/35 CM
DIA 45 - H 45 CM

CHR95520
CHR95519
CHR95556
CHR95518
CHR95517
CHR95516





Cube Charlie

W 45 - D 45 - H 45 CM

CHR98824



Cube Four

W 45 - D 45 - H 45 CM

CHR97034



Bench Ritz



W 100 - D 45 - H 40 CM
W 120 - D 45 - H 45 CM
W 150 - D 45 - H 40 CM

CHR95499
CHR95588
CHR95498

Sofas



COMFY & ZEN

Hét recept voor een comfortabele en rustgevende zithoek ligt hem in het toelaten van eenvoud.

The recipe for a comfortable and restful seating area lies in allowing simplicity.

Citizen

Info on p. 240-241



Customizable

Arm: 15 cm

Arms flow into back



Onze 'customizable' sofa's kunnen aangepast worden naar wens. In dit project werd bijvoorbeeld de arm van de sofa smaller gemaakt.

Our 'customizable' sofas can be modified to suit your needs. In this project, for example, we narrowed down the arm of the sofa.



Metropole



Info on p. 260-261

Customizable



Devino



Info on p. 244-245

Customizable





Adisson



Info on p. 226-227

Customizable



Nano



Info on p. 264-265

Fixed sizes



Brandon



Info on p. 234-235

Customizable



Baldwin



Info on p. 230-231

Fixed sizes





North meets east

Zitcombinatie Bixby low biedt het beste van twee werelden: het heerlijke comfort uit het noorden, gecombineerd met de elegante strakke vormgeving uit Japan. De karakteristieke lage, diepe kussens en de strakke poten in zwart hout typeren de esthetiek van de populaire woonstijl Japandi.

Seat combination Bixby low offers the best of both worlds: the wonderful comfort from the north, combined with the elegant sleek design from Japan. The characteristic low, deep cushions and sleek legs in black wood typify the aesthetic of the popular Japandi living style.

Bixby low



Info on p. 232-233

Fixed sizes



Durant



Info on p. 248-249

Fixed sizes



Dallas



Info on p. 242-243

Customizable



Tulsa



Info on p.276-277

Fixed sizes

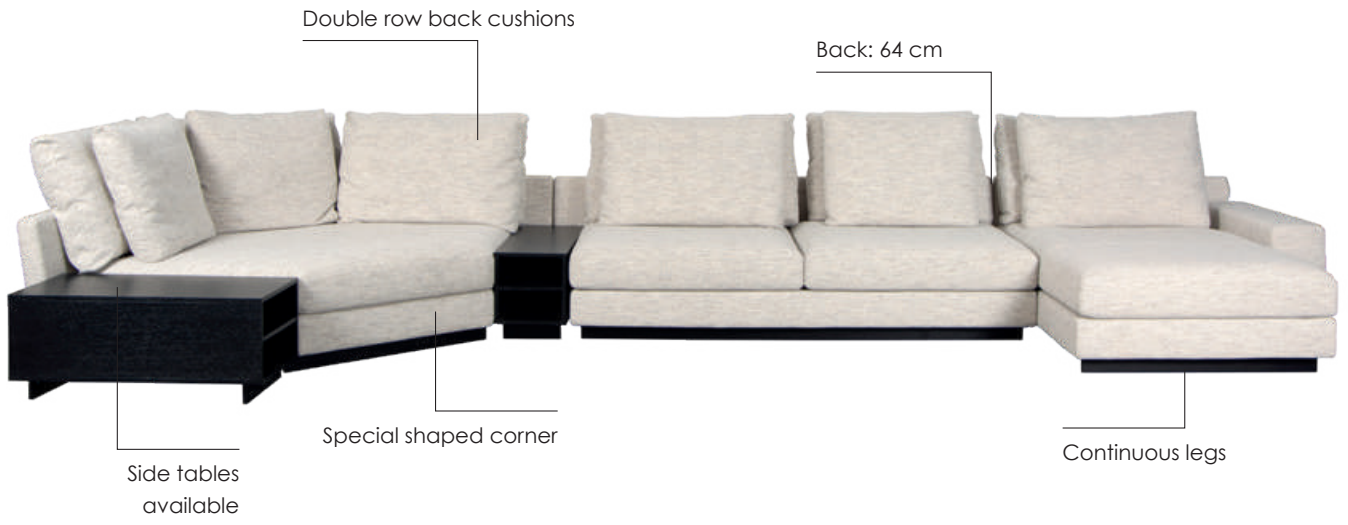

Cibeau



Info on p. 238-239

Fixed sizes





Lars

Info on p. 255

Fixed sizes





Selva



Info on p. 270-271

Fixed sizes

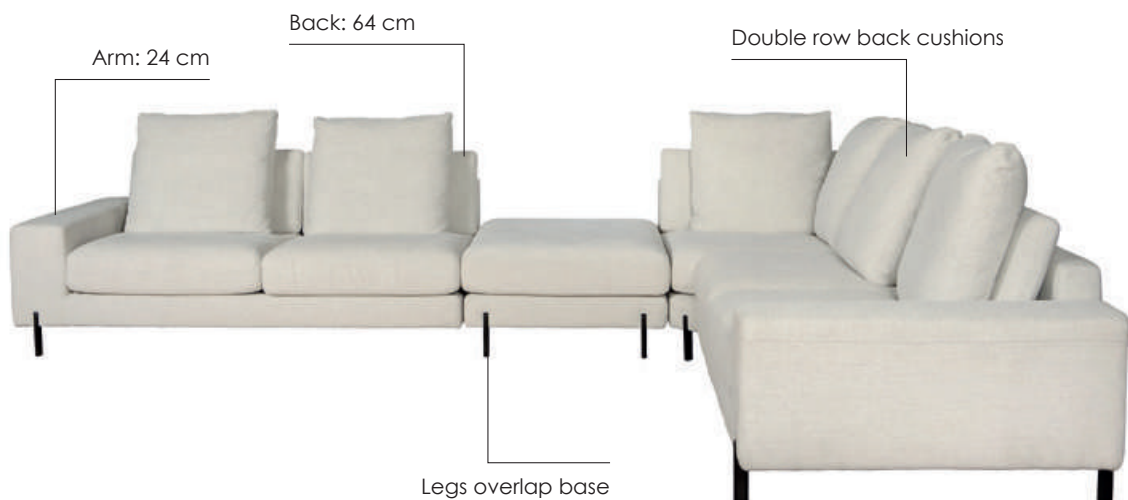

Norman

Info on p. 266-267



Fixed sizes



Yukon

Info on p. 278-279



Fixed sizes



Leonard

Info on p. 256-257



Fixed sizes





Gomez



Info on p. 250-251

Fixed sizes





Abby

Info on p. 224-225



Fixed sizes



Discovery



Info on p. 246-247

Customizable



Houston



Info on p. 252-253

Customizable





Amazing grace

De genialiteit van een ontwerp, hoe verschillend ze ook zijn, zit in zowel de eenvoud als in de details. In dit geval zorgen de fijne poten voor een elegante en luchtige look.

The genius of a design, however different they may be, lies in both simplicity and details. In this case, the delicate legs create an elegant and airy look.

Asuri



Available in: 125, 180, 200, 220, 240, 260, 280, 300 CM

Customizable



Lou



Info on p. 258-259

Fixed sizes

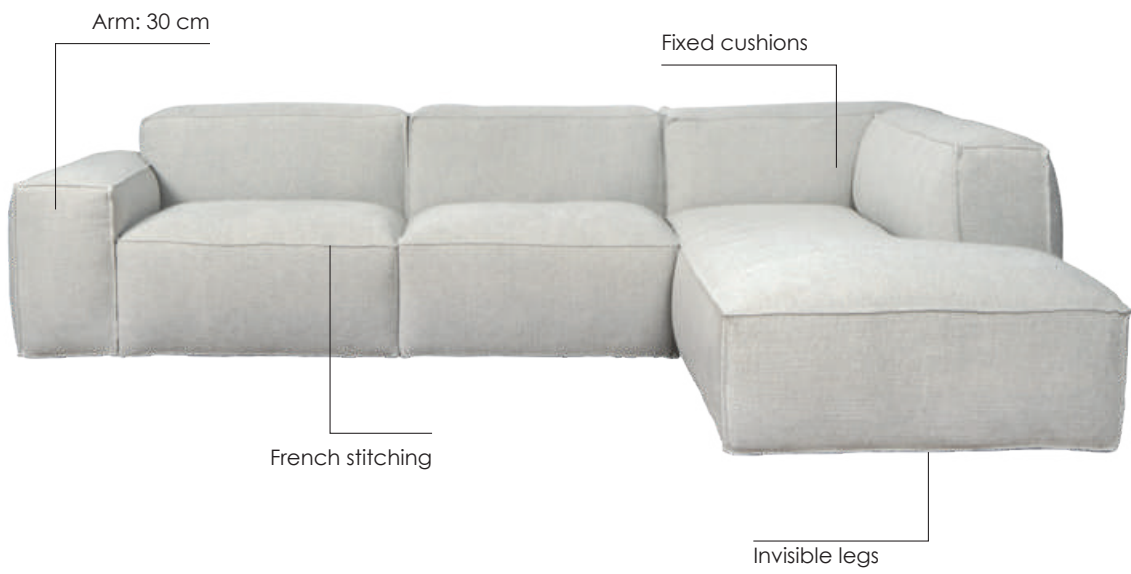

Alanis

Info on p. 228



Fixed sizes





Lunettes



Available in: 180, 200, 220, 240, 260, 280, 300 CM

Customizable

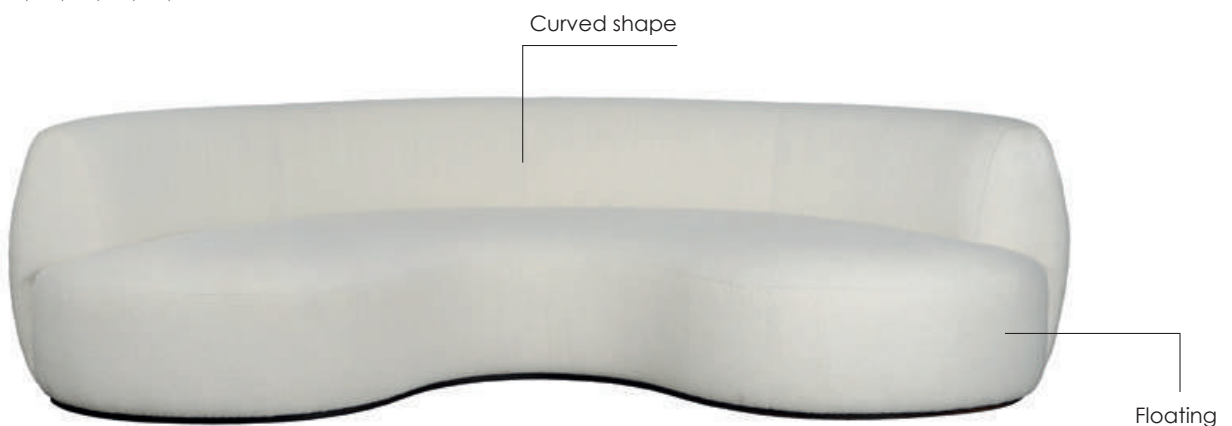

Noora



Available in: 200, 225, 265, 300 CM

Customizable



Shaped

Vloeiende lijnen, een eigenzinnig assymetrisch design. De bijzondere vorm zorgt ervoor dat de veelal strakke lijnen van je interieur doorbroken worden. Lady Anne weet de aandacht vast te houden.

Flowing lines, a quirky assymetric design. The unusual shape breaks the clean lines of your interior. Lady Anne knows how to hold your attention.



Lady Anne

Available in: 225, 250, 275, 300 CM



Customizable



CLASSIC COLLECTION

Bij onze klassiekers vind je de vaste waarden. De ambachtelijke stijliconen in landelijke stijl waar Charrell al jaar en dag bekend om staat.

You will find the 'regulars' among our classics. These are the artisanal, rustic style icons for which Charrell has been known for years.



184 | Cabinets

- 186 Display cabinets
- 192 Sideboards
- 194 Tv cabinets

196 | Tables & side furniture

- 198 Dining tables
- 200 Desks



202 | Chairs

- 204 Dining chairs
- 208 Counter- & bar chairs

210 | Seats & sofas

- 212 Seats
- 216 Sofas

Cabinets

Centraal staan het creëren van een gezellige atmosfeer en liefde voor het materiaal. Stijl en functie ontmoeten elkaar in tijdloze opbergmeubels.

Creating a cosy atmosphere and a love of materials are the main focus. Style and function meet in timeless storage furniture.



Display cabinets



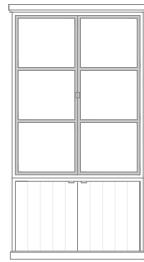

**CABINET LANCASTER
2 PARTS**
W 125 - D 48 - H 230 CM
CAB99514-RO

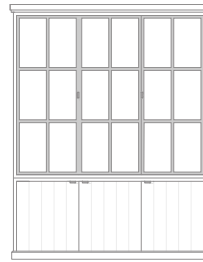

**CABINET LANCASTER
3 PARTS**
W 180 - D 48 - H 230 CM
CAB99106-RO



**CABINET LANCASTER 220
4 PARTS**
W 220 - D 48 - H 230 CM
CAB99515-RO

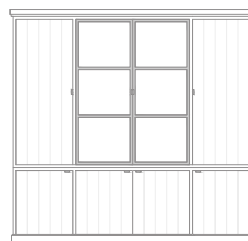

**CABINET LANCASTER 245
4 PARTS**
W 245 - D 48 - H 230 CM
CAB97757-RO

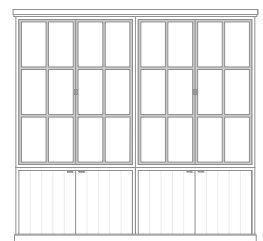

**CABINET LANCASTER 245
4 PARTS ALL GLASS**
W 245 - D 48 - H 230 CM
CAB99105-RO

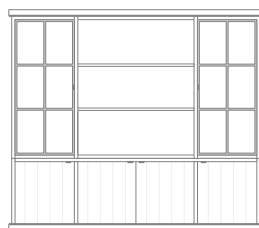

**CABINET LANCASTER 267
4 PARTS MIDDLE OPEN**
W 267 - D 48 - H 230 CM
CAB97350-RO

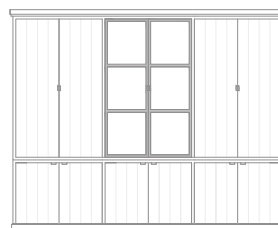

**CABINET LANCASTER
6 PARTS**
W 290 - D 48 - H 230 CM
CAB99101-RO



Corby



Massive oak / oak veneer



**BOOKCASE CORBY 115
ALL GLASS**
W 115 - D 40 - H 235 CM
CAB97826-RO



**BOOKCASE CORBY 115
PLAIN DOORS**
W 115 - D 40 - H 235 CM
CAB97663-RO



**BOOKCASE CORBY 115
OPEN**
W 115 - D 40 - H 235 CM
CAB97664-RO



**WARDROBE CORBY
2 PARTS**
W 145 - D 60 - H 215 CM
CAB97825-RO

De Corby collectie blijft interieurs betoveren door de eenvoud van het design, met toch dat landelijk kantje. Wij helpen je graag bij het maken van de juiste keuze uit de verschillende modellen, maten en afwerkingen!

The Corby collection continues to enchant interiors with its simple design and a touch of country living. We would love to help you choose the right models, dimensions and finishes!

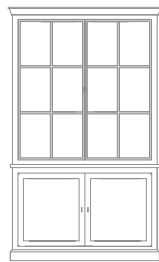

**CABINET CORBY
2 PARTS**
W 150 - D 51 - H 235 CM
CAB97896-RO

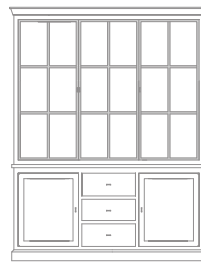

**CABINET CORBY
3 PARTS**
W 180 - D 51 - H 235 CM
CAB97897-RO

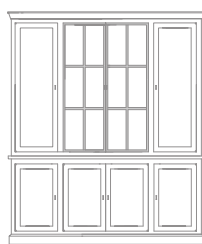

**CABINET CORBY 210
4 PARTS**
W 210 - D 51 - H 235 CM
CAB97898-RO

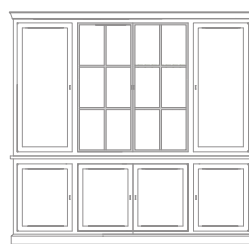

**CABINET CORBY 240
4 PARTS**
W 240 - D 51 - H 235 CM
CAB97899-RO



**CABINET CORBY 240
4 PARTS / 4 DRAWERS**
W 240 - D 51 - H 235 CM
CAB96979-RO

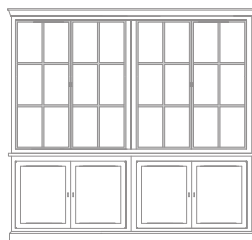

**CABINET CORBY 240
4 PARTS ALL GLASS**
W 240 - D 51 - H 235 CM
CAB97900-RO

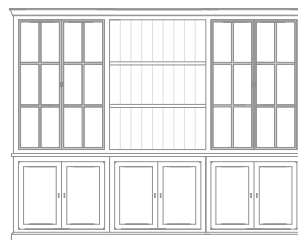

**CABINET CORBY 290
6 PARTS**
W 290 - D 51 - H 235 CM
CAB97662-RO

Dockx



Massive oak / oak veneer

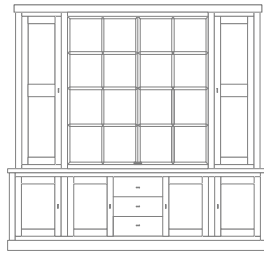

CABINET DOCKX
W 250 - D 48 - H 240 CM
CAB96597-RO

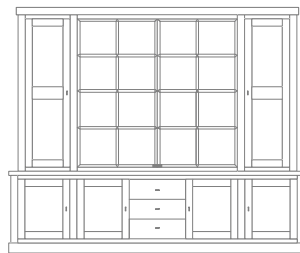

CABINET DOCKX
W 290 - D 48 - H 240 CM
CAB96651-RO

Here
to stay

Cabinet Dockx is een all time favorite die een mooi compromis biedt tussen opbergen en etaleren. Deze cabinet zorgt voor een mooie balans tussen eigentijds design en een rustieke touch door het gebruik van authentieke materialen.

Cabinet Dockx is an all-time favourite that offers a nice compromise between storage and display. This cabinet strikes a nice balance between contemporary design and a rustic touch by using authentic materials.

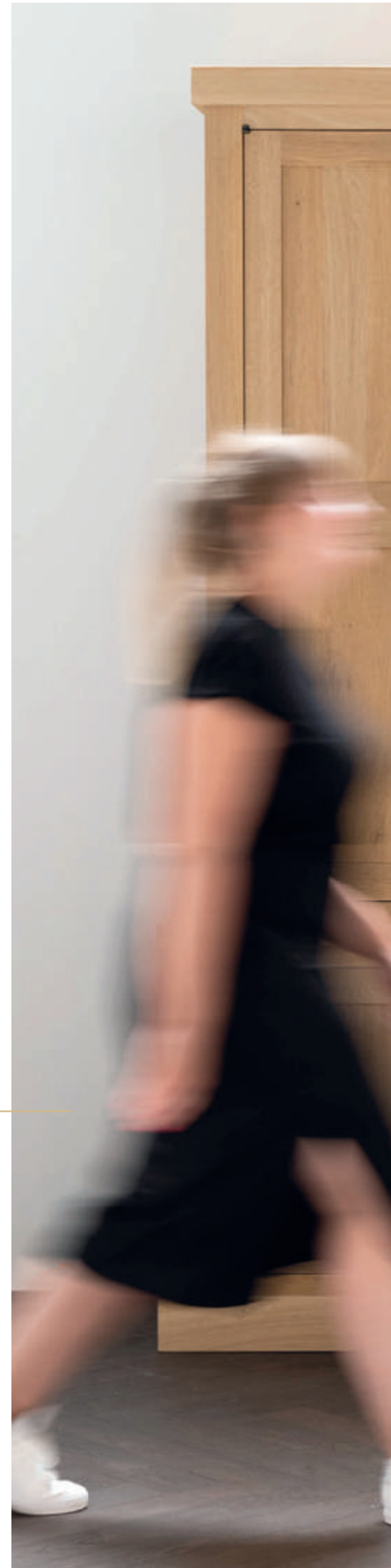



Sideboards





Lancaster

Massive oak / oak veneer

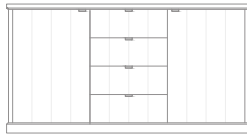

SIDEBOARD LANCASTER 180
2 DOORS / 4 DRAWERS
W 180 - D 45 - H 95 CM
CAB97756-RO

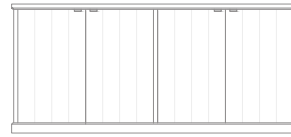

SIDEBOARD LANCASTER 210
4 DOORS
W 210 - D 45 - H 95 CM
CAB97755-RO



SIDEBOARD LANCASTER 240
4 DOORS / 4 DRAWERS
W 240 - D 45 - H 95 CM
CAB99513-RO

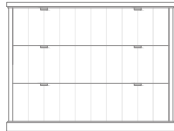

DRESSER LANCASTER 120
3 DRAWERS
W 120 - D 45 - H 95 CM
CAB99154-RO



Corby

Massive oak / oak veneer

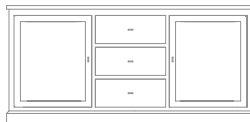

SIDEBOARD CORBY 180
2 DOORS / 3 DRAWERS
W 180 - D 51 - H 95 CM
CAB97893-RO

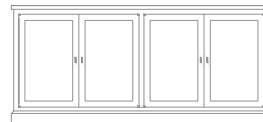

SIDEBOARD CORBY 210
4 DOORS
W 210 - D 51 - H 95 CM
CAB97892-RO

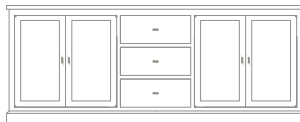

SIDEBOARD CORBY 240
4 DOORS / 3 DRAWERS
W 240 - D 51 - H 95 CM
CAB97894-RO

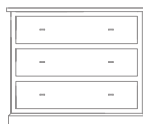

DRESSER CORBY 120
3 DRAWERS
W 120 - D 51 - H 95 CM
CAB97895-RO

Tv cabinets





Lancaster

Massive oak / oak veneer



TV CABINET LANCASTER 150
2 DRAWERS
W 150 - D 50 - H 55 CM
CAB97753-RO

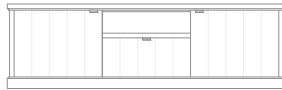

TV CABINET LANCASTER 175
2 DOORS / 1 DRAWER
W 175 - D 50 - H 55 CM
CAB97752-RO

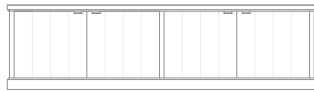

TV CABINET LANCASTER 200
4 DOORS
W 200 - D 50 - H 55 CM
CAB97751-RO

Corby



Massive oak / oak veneer

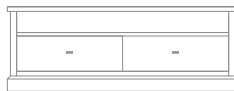

TV CABINET CORBY 150
2 DRAWERS
W 150 - D 50 - H 55 CM
CAB97824-RO

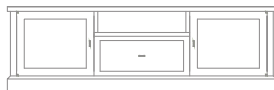

TV CABINET CORBY 175
2 DOORS / 1 DRAWER
W 175 - D 50 - H 55 CM
CAB97890-RO

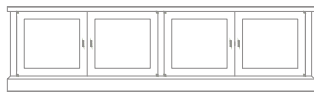

TV CABINET CORBY 200
4 DOORS
W 200 - D 50 - H 55 CM
CAB97889-RO

Tables & side furniture

Sommige dingen veranderen nooit. Ook anno 2023 blijft de eettafel het kloppende hart van je huis. De essentie gekoppeld aan puur genot.

Some things never change. Even anno 2023, the dining table remains the beating heart of your home. The essence combined with pure enjoyment.



Dining tables



Bexhill

H 76 CM
FH 71 CM



Massive oak



W 260 - D 110 CM
W 280 - D 110 CM
W 300 - D 110 CM

TBL98231-RO
TBL98232-RO
TBL98425-RO



Marchwood

H 76 CM
FH 72 CM



Massive oak



W 200 - D 100 CM
W 220 - D 100 CM
W 240 - D 100 CM
W 260 - D 100 CM
W 280 - D 110 CM
W 300 - D 110 CM

TBL98225-RO
TBL98226-RO
TBL98227-RO
TBL98228-RO
TBL98229-RO
TBL98230-RO



Auckland

H 76 CM
FH 72 CM



Massive oak



W 240 - D 100 CM
W 260 - D 100 CM
W 280 - D 110 CM
W 300 - D 110 CM

TBL98426-RO
TBL98430-RO
TBL98233-RO
TBL98234-RO



Een robuuste, landelijke eettafel is een echte eye-catcher in huis. In deze setting draagt de zwarte afwerking, in combinatie met stoelen in lederlook, een stalen hanglamp en betonnen vloer bij tot een ietwat industriële sfeer.

A sturdy, country-style dining table is a real eye-catcher in your home. Here, the black finish, combined with leather-look chairs, a steel pendant light and concrete floor, creates a hint of industrial style.



Desks





Lancaster

Massive oak / oak veneer

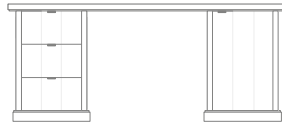

DESK LANCASTER 180
LEATHER TOP
W 180 - D 80 - H 77 CM
TBL98514-RO



Corby

Massive oak / oak veneer



DESK CORBY 180
LEATHER TOP
W 180 - D 80 - H 77 CM
TBL97724-RO



Chairs

Design is een constante uitdaging om balans te vinden tussen comfort en luxe, tussen het praktische en het gedroomde.

Design is a constant challenge to balance comfort with luxe, the practical with the desirable.



Dining chairs



Royalty

De knopen in de rug bij deze klassieke gecapitonneerde eetkamerstoel zorgen voor het kenmerkende gevoel van luxe en grandeur. Met de stofkeuze bepaal je de ultieme look.

The buttons in the back on this classic padded dining chair create the distinctive feeling of luxury and grandeur. With the choice of fabric you determine the ultimate look.



Chair Arnaud



W 52 - D 60 - H 104 CM CHR99348
HS 49 CM



Chair Dominique



W 54 - D 66 - H 102 CM CHR99173
HS 49 CM



Chair Adam



W 57 - D 65 - H 86 CM CHR99047
HS 49 CM



Armchair Adam



W 61 - D 68 - H 86 CM CHR99048
HS 49 - HA 64 CM



Armchair Elena



W 62 - D 67 - H 91 CM CHR98624
HS 50 - HA 63 CM



Armchair Clios



W 58 - D 61 - H 83 CM CHR97594
HS 49 CM - HA 69 CM



Chair Anna



W 52 - D 65 - H 88 CM CHR99465
HS 49 CM





Chair Aragon



W 49 - D 59 - H 84 CM CHR99210
HS 49 CM



Armchair Aragon



W 55 - D 60 - H 84 CM CHR99209
HS 49 - HA 65 CM



Armchair Robin



W 57 - D 58 - H 79 CM CHR98345
HS 49 - HA 64 CM

Counter- & bar chairs





**Chair Aragon
counter/bar**



W 49 - D 59 - H 99/114 CM
COUNTER HS 65 CM
BAR HS 80 CM

CHR99053
CHR99055



**Armchair Aragon
counter/bar**



W 58 - D 61 - H 99/114 CM
HA 81,5/96,5 CM
COUNTER HS 65 CM
BAR HS 80 CM

CHR99208
CHR99054



**Chair Robin
counter/bar**



W 48 - D 57 - H 95/107 CM
COUNTER HS 65 CM
BAR HS 80 CM

CHR97993
CHR97992



**Armchair Robin
counter/bar**



W 57 - D 59 - H 97/112 CM
HA 80,5/95,5 CM
COUNTER HS 65 CM
BAR HS 80 CM

CHR97994
CHR97991

Casual

Ongedwongen genieten aan het ontbijt, gezellig samen aperitieven na een lange werkdag, een tas koffie en een babbeltje... Een leefkeuken is dikwijls de kern van je huis. Met onze counter chairs zorg je voor ultiem comfort én tijdloze klasse.

Enjoying a relaxed breakfast, a cosy aperitif after a long day at work, a cup of coffee and a chat... A living kitchen is often the heart of your home. Our counter chairs provide ultimate comfort and timeless class.

Seats & sofas

Gedesigned naar jouw noden. Om comfort te geven,
op maat van jouw gezin. In jouw stijl.

Designed to suit your needs. To give comfort,
customised for your family. In your style.



Seats





Seat Maurice



W 70 - D 84 - H 73 CM CHR97018
HS 46 CM - HA 64 CM



Seat Gio



W 70 - D 75 - H 82 CM CHR96137
HS 45 CM - HA 62 CM



Seat Clinton



W 81 - D 75 - H 71 CM CHR97587
HS 42 CM



Seat Ollie



W 69 - D 70 - H 76 CM CHR95511



More than just pretty

Een accent fauteuil is meer dan gewoon 'mooi'. Ontworpen met een sterk oog voor detail, transformeren onze seats een saai hoekje of geven een frisse touch aan je interieur.

An accent armchair is more than just 'pretty'. Designed with a strong eye for detail, our seats transform a dull corner or add a fresh touch to your interior.



Seat Jennifer



W 73 - D 80 - H 82 CM CHR99149
HS 45 CM - HA 64 CM



Seat Sven



W 77 - D 90 - H 106 CM CHR97888
HS 45 CM - HA 63 CM



Seat Noah



W 77 - D 99 - H 89 CM CHR97016
HS 35 CM - HA 53 CM





Fauteuil Wellington



W 83 - D 90 - H 107 CM CHR96369
HS 49 CM - HA 65 CM
OPTION: BUTTONS CHR96370



Sofas



Pauline



Info on p. 268-269

Customizable



Paulette



W 180 - D 94 - H 85 CM

Customizable



Zermatt



Info on p. 280-281

Customizable

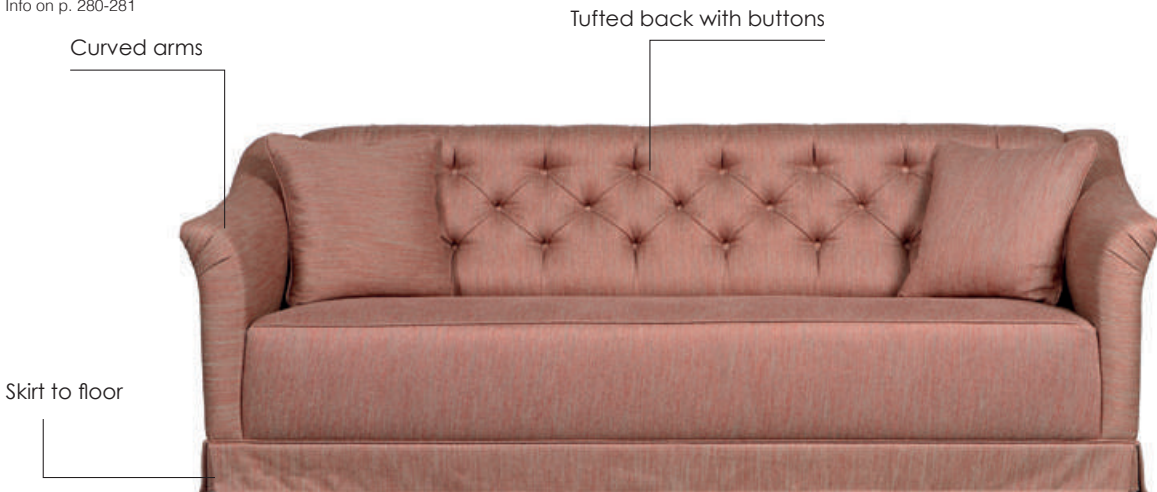

Sienna



Info on p. 272-273

Customizable



Torino



Info on p. 274-275

Customizable



Moore



Info on p. 262-263

Fixed sizes



Leuk detail waarbij de arm wat naar achter springt.

Nice detail where the arm jumps back a bit.

Mid-century Lush

Er gaat een onmiskenbare charme uit van deze stijlvolle sofa's. De elegantie zit in de details, zoals de gebogen vorm van de armleuning. Het luxueuze gevoel in de keuze van de stof. (Vraag ons naar de mogelijkheden).

An undeniable charm emanates from these stylish sofas. The elegance is in the details, such as the curved shape of the armrest. The luxurious feel in the choice of fabric (ask us about the options).

Juneau



Info on p. 254

Fixed sizes



Champ



Info on p. 236

Fixed sizes







SOFA SETUPS & OPTIONS

De sofa's uit onze collectie hebben, afhankelijk van de leverancier, bepaalde mogelijkheden tot maatvoeringen en samenstellingen. Graag lichten we dit toe aan de hand van technische fiches.

Depending on the supplier, the sofas in our collection have certain possibilities in terms of dimensions and compositions. We would like to explain this by providing technical data information.



De sofa die het nodige comfort biedt, past in je interieurstijl én qua verhoudingen klopt, dat vraagt enig voorbereidend werk.

Een groot deel van onze sofa's kunnen helemaal op maat gemaakt worden, in een stof naar keuze. Dit zorgt ervoor dat er creatieve oplossingen kunnen gezocht worden, op maat. Andere modellen bieden dan weer verschillende maten aan, om ook zo tot een gewenst resultaat te komen.

A sofa that offers the necessary comfort, fits your interior style and has the right proportions requires some preparatory work.

Many of our sofas can be made entirely to measure, in a fabric of your choice. This allows for creative, tailor-made solutions. Other models offer different sizes, to achieve the desired result.

Abby

Width arms: 20 cm

Height legs: 19 cm

Sitting height: ca. 44 cm

Total height: ca. 80 cm

Total depth: ca. 100 cm

Legs: black metal

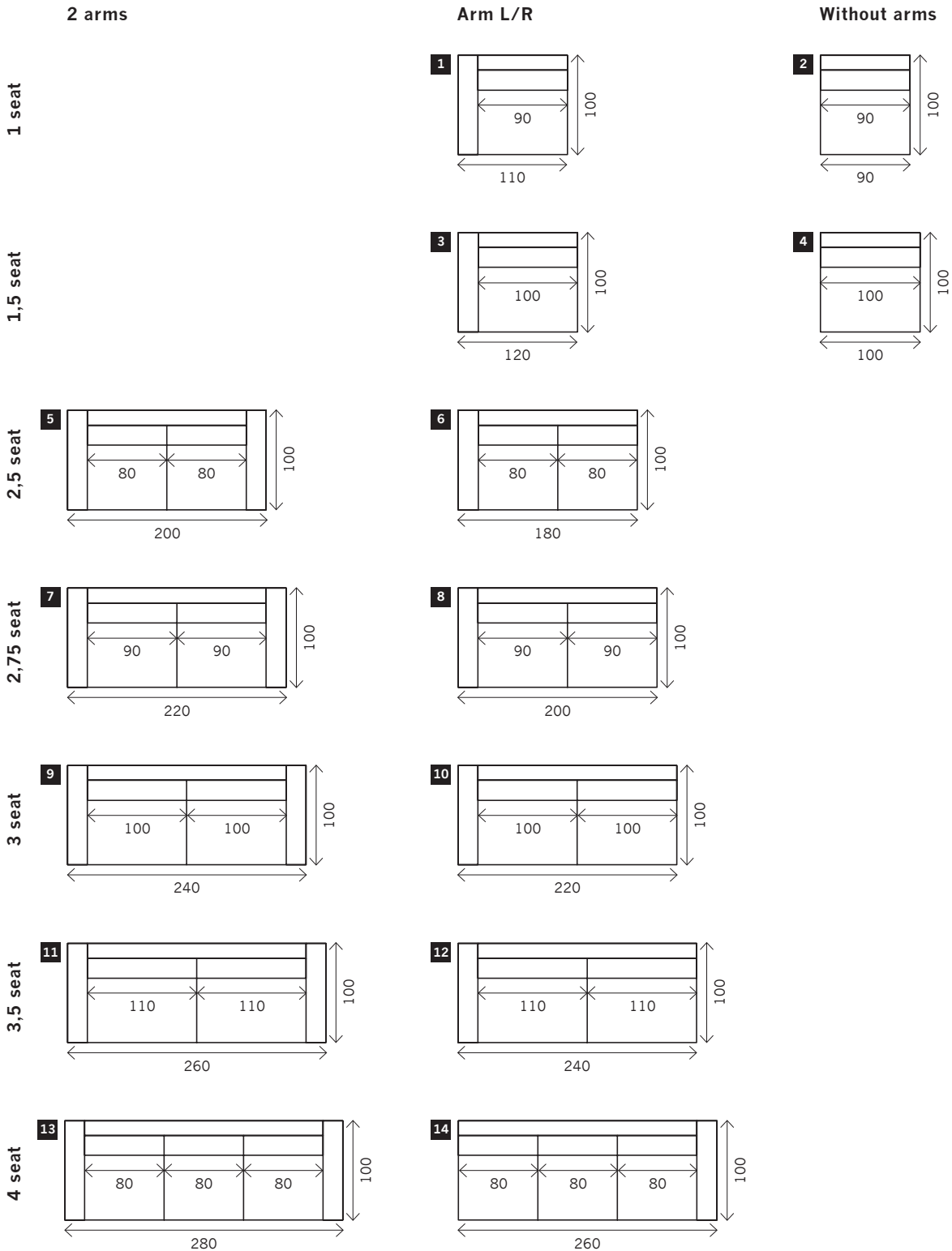

Corner L/R

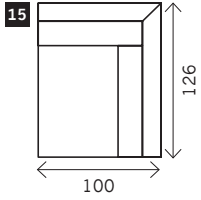

Pouf

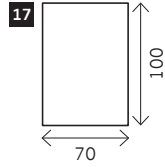
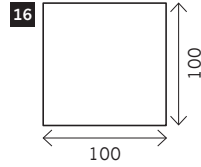

Ottomane L/R

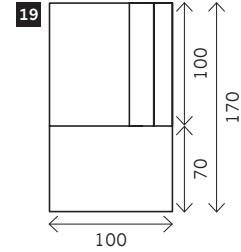
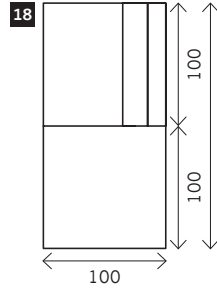

Meridienne L/R

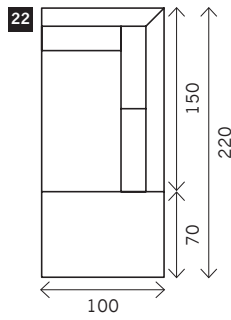
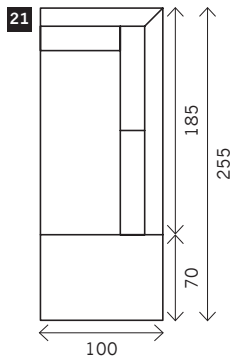
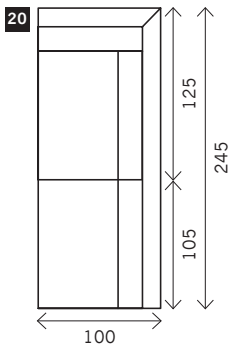

Longchair L/R

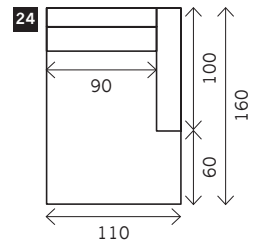
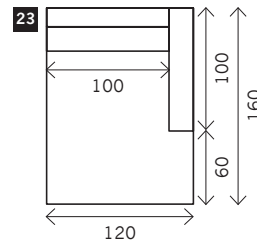

Examples corner sofas

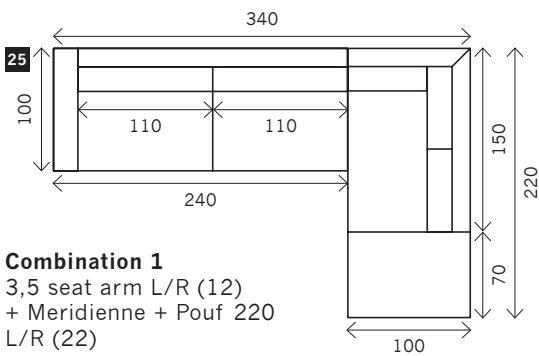

Combination 1
 3,5 seat arm L/R (12)
 + Meridienne + Pouf 220
 L/R (22)

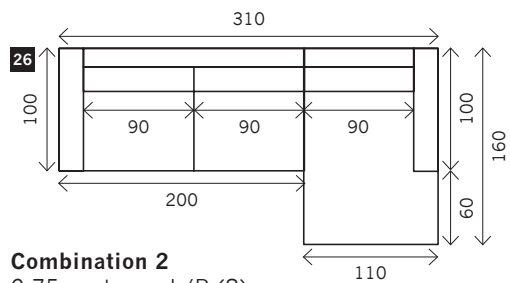

Combination 2
 2,75 seat arm L/R (8)
 + Longchair 110 L/R (24)

Adisson

Width arms: 20 cm
Height legs: 5 cm
Sitting height: ca. 41 cm
Total height: ca. 85 cm
Total depth: ca. 100 cm

Toss cushions 45 x 45 cm:
 Seats with 2 arms: 2x
 Seats with 1 arm/Meridienne/Longchair: 1x



2 arms

Arm L/R

Without arms

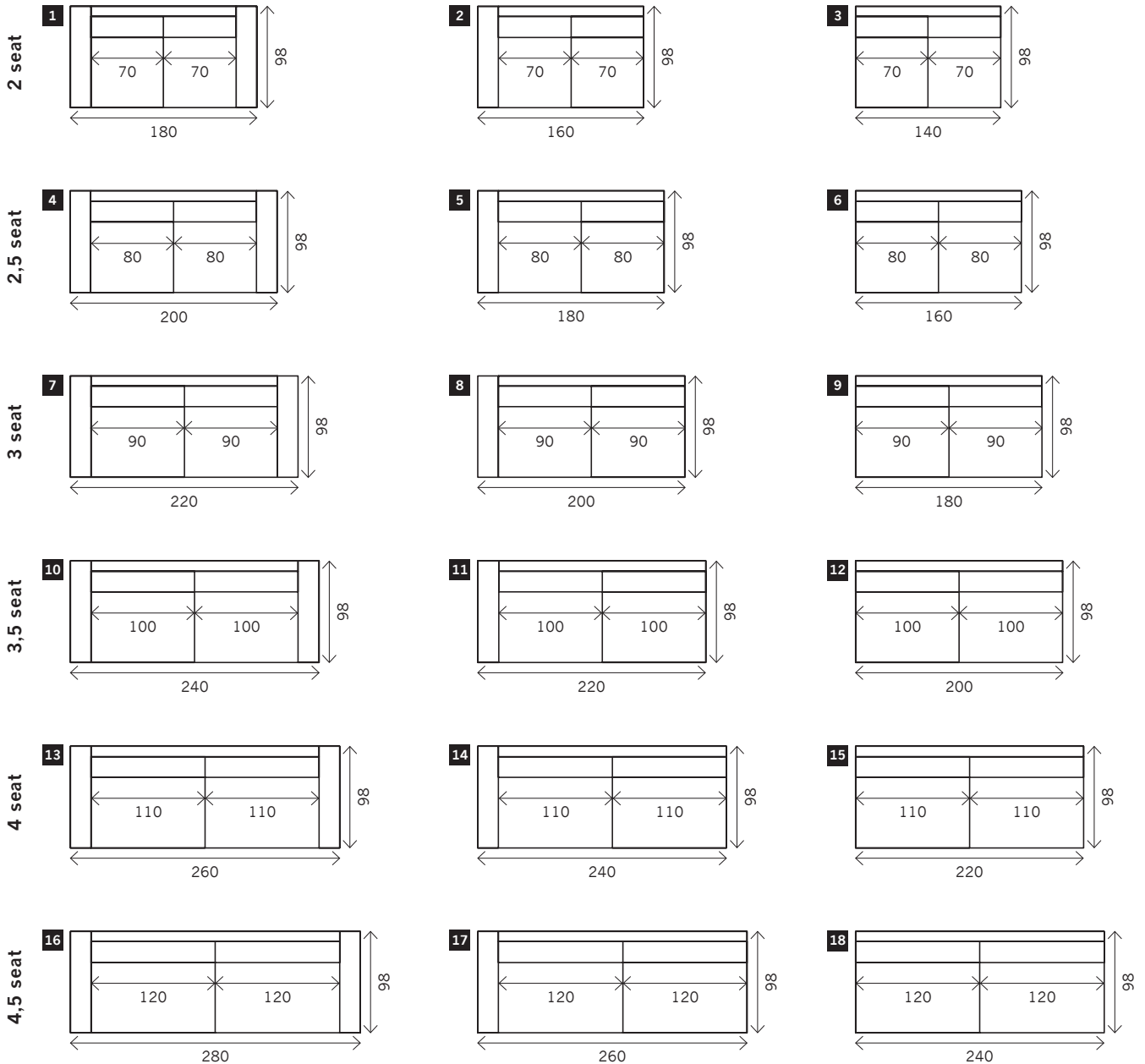

Corner

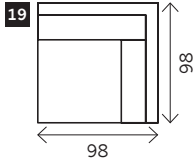

Pouf

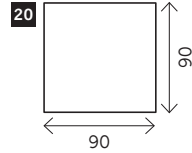

Square:

90 x 90 / 100 x 100 / 110 x 110

Rectangle:

90 x 70 / 100 x 70 / 110 x 70

Meridienne L/R

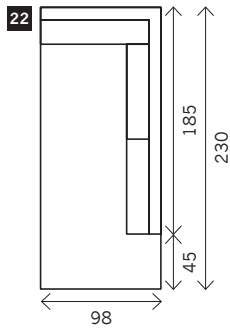
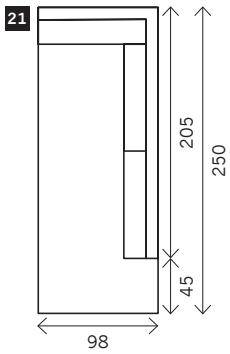

Longchair L/R

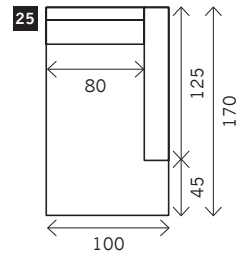
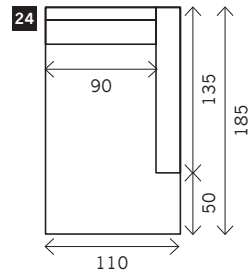
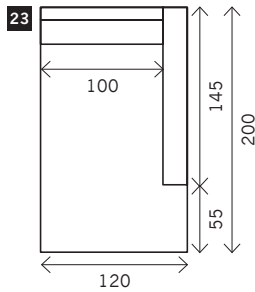

Examples corner sofas

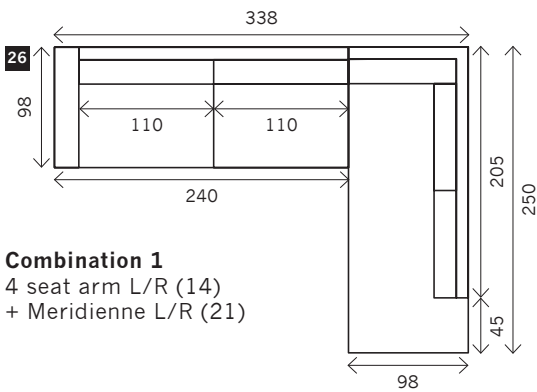

Combination 1

4 seat arm L/R (14)
+ Meridienne L/R (21)

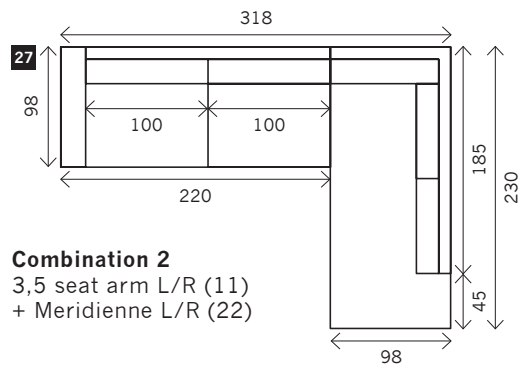

Combination 2

3,5 seat arm L/R (11)
+ Meridienne L/R (22)

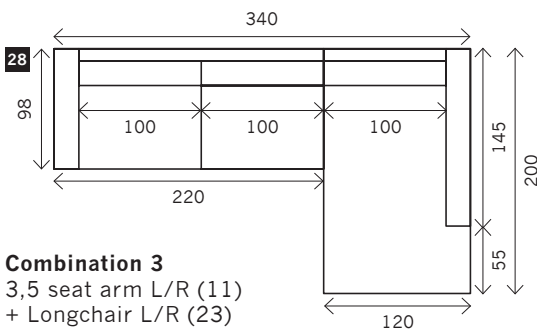

Combination 3

3,5 seat arm L/R (11)
+ Longchair L/R (23)

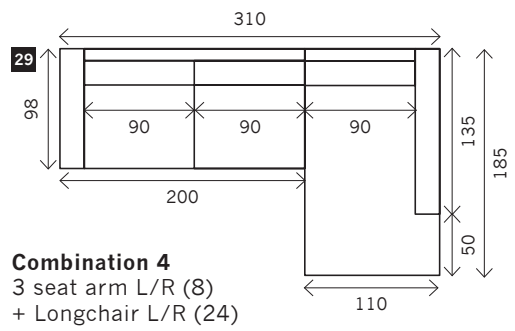

Combination 4

3 seat arm L/R (8)
+ Longchair L/R (24)

Alanis

Width arms: 32 cm
Height legs: 6 cm
Sitting height: ca. 39 cm
Total height: ca. 76 cm
Total depth: ca. 109 / 124 cm



Depth 109

Depth 124

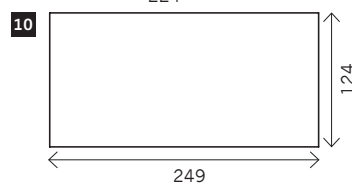
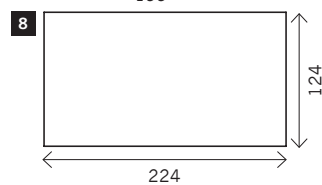
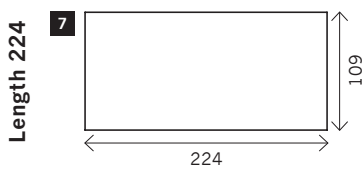
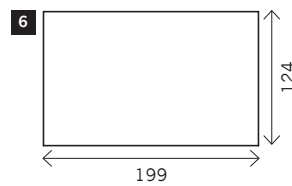
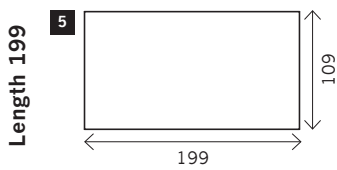
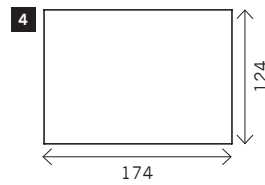
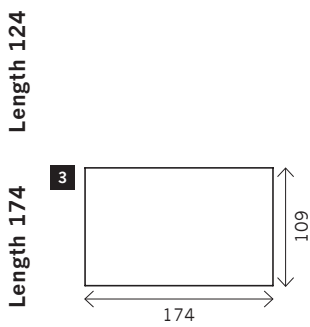
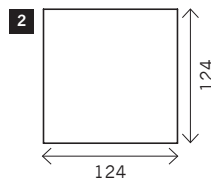
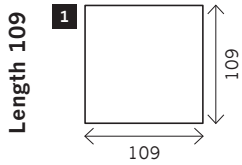

Corner left

Corner right

Trapezium 124 down

Trapezium 109 down

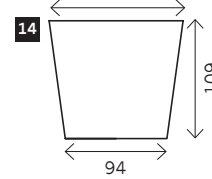
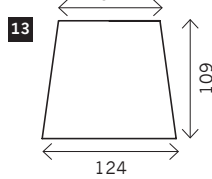
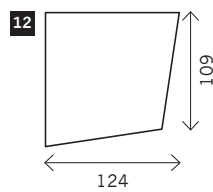
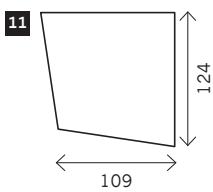

Armrest

Back cushion

Extra cushion

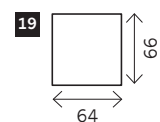
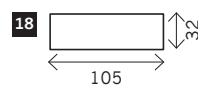
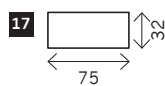
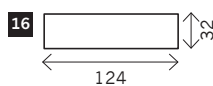
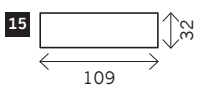

Aleto

Width arms: 4 cm
Height legs: 21 cm
Sitting height: ca. 40 cm
Total height: ca. 74 cm
Total depth: ca. 83 cm

Legs: dark oak / canaletto walnut



2 arms

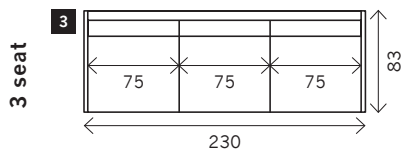
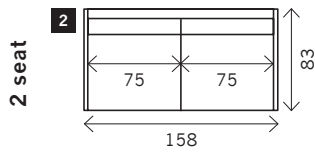
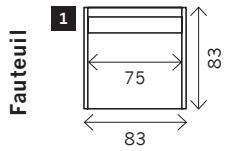

Baldwin

Width arms: 25 cm
Height legs: 4 cm
Sitting height: ca. 41 cm
Total height: ca. 85 cm
Total depth: ca. 103 cm

Toss cushions 45 x 45 cm:
 Seats with 2 arms: 2x
 Seats with 1 arm/Meridienne/Longchair: 1x



2 arms

Arm L/R

Without arms

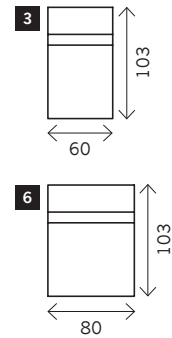
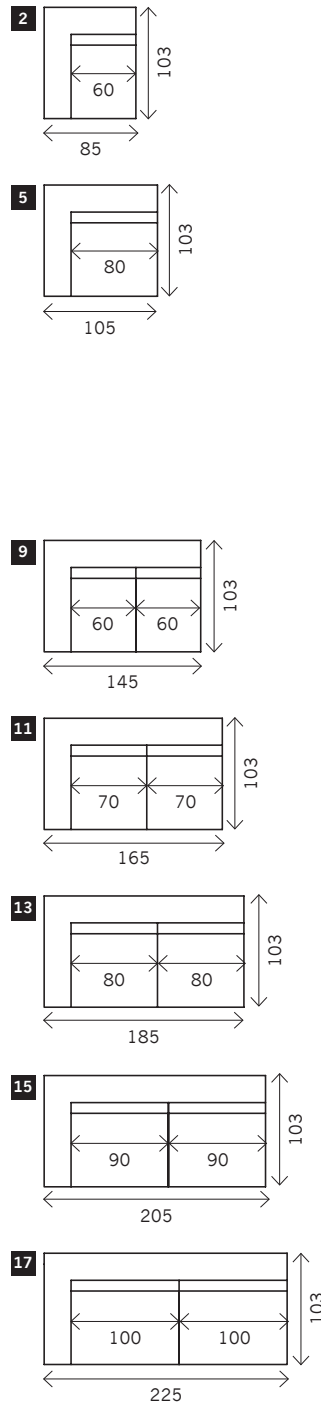
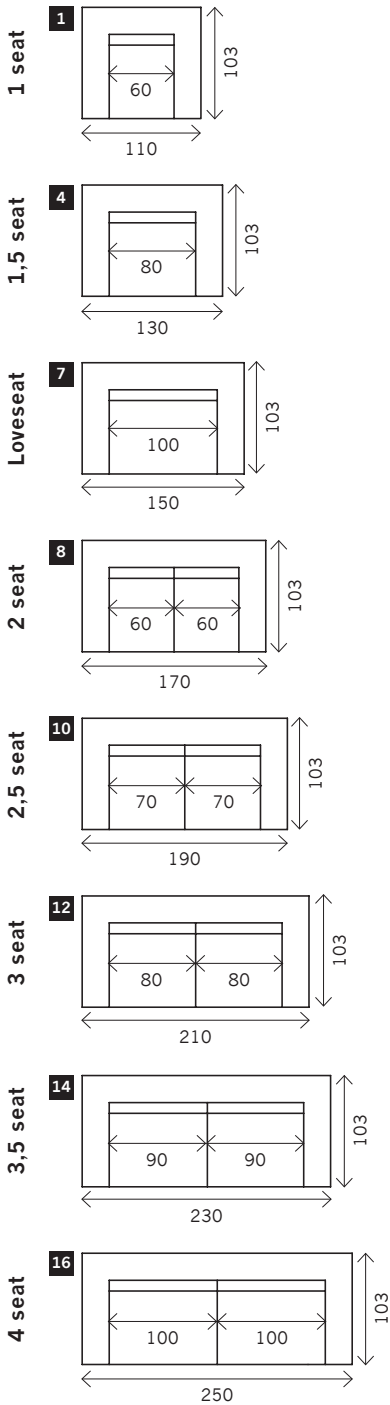

Corner

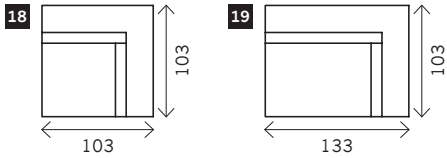

Pouf

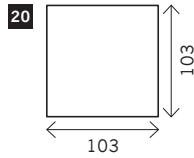

Rectangle:
70 x 103

Meridienne L/R

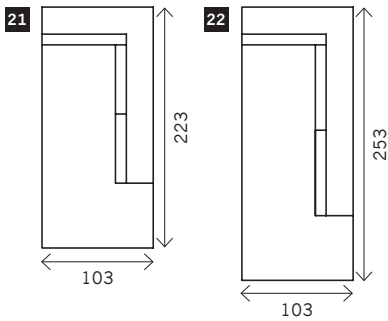

Longchair L/R

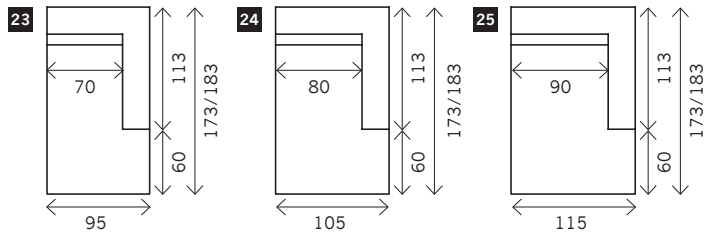

Examples corner sofas

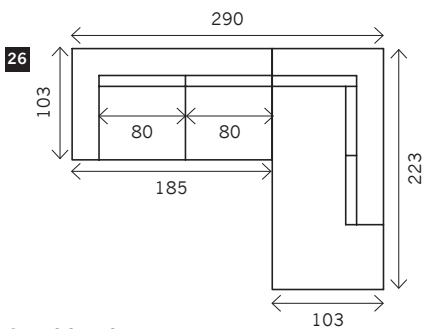

Combination 1
2,5 seat arm L/R (12)
+ Meridienne L/R (22)

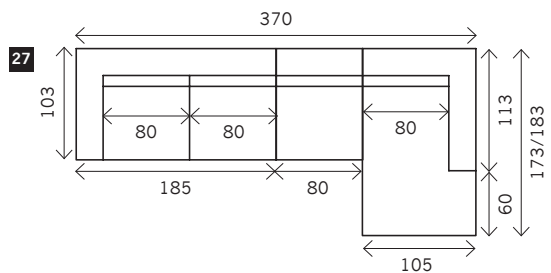

Combination 2
3 seat arm L/R (16)
+ 1,5 seat without arms (6)
+ Longchair L/R (25)

Bixby low

Width arms: 28 cm
Height legs: 10 cm
Sitting height: ca. 40 cm
Total height: ca. 107 cm
Total depth: ca. 74 cm

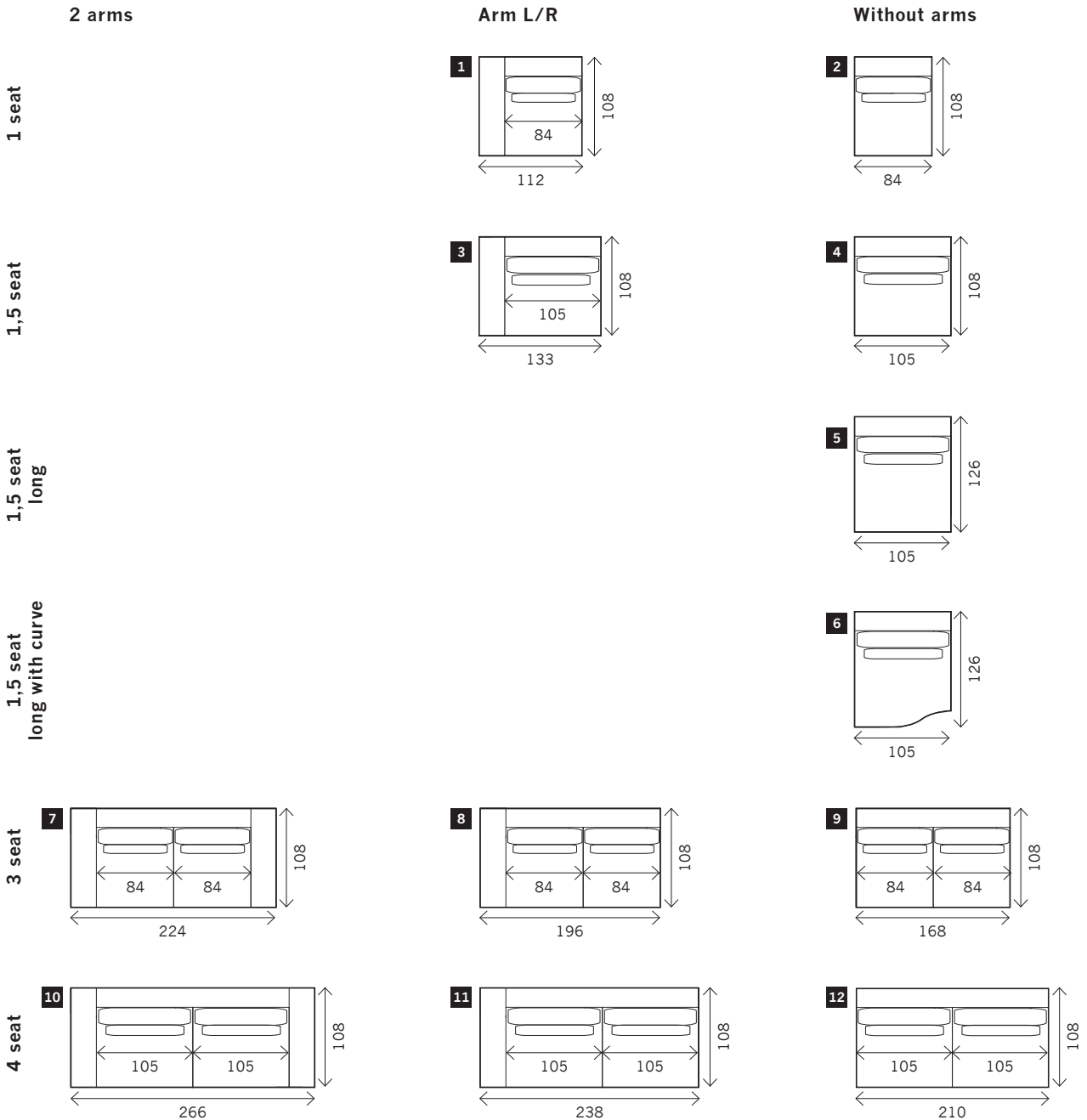

Corner L/R

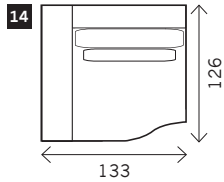
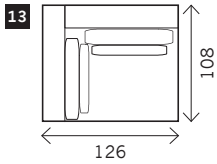

Pouf

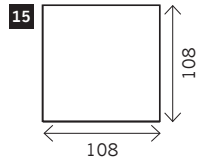

Rectangle:
63 x 108
88 x 108
63 x 126

Pouf with carré

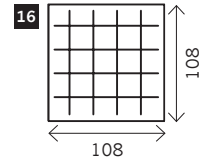

Rectangle:
63 x 108
88 x 108
63 x 126

Longchair L/R

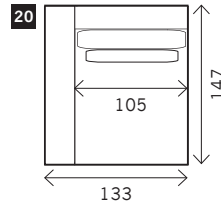
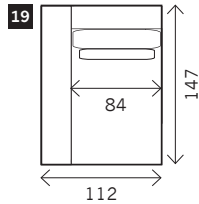
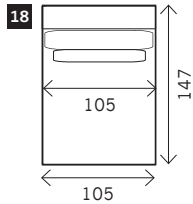
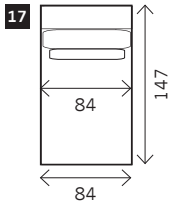

Examples corner sofas

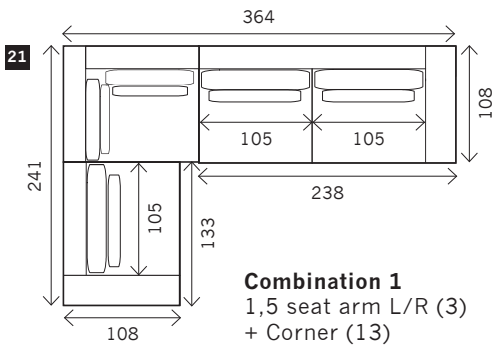

Combination 1
1,5 seat arm L/R (3)
+ Corner (13)
+ 4 seat arm L/R (11)

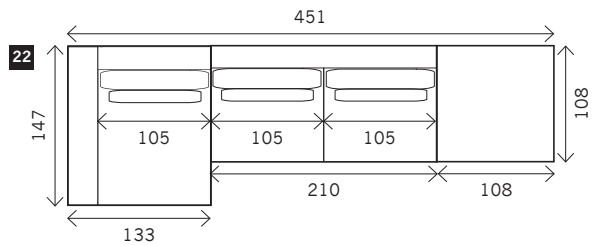

Combination 2
Longchair 133 arm L/R (20)
+ 4 seat without arm (12)
+ Pouf square (15)

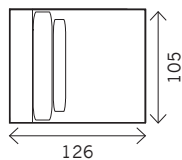
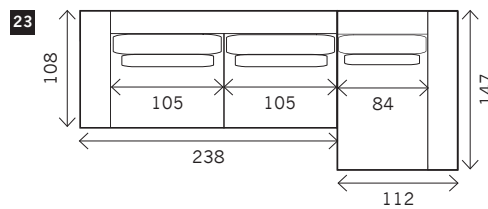

Combination 3
4 seat arm L/R (11)
+ Longchair 112 arm L/R (19)
+ 1,5 seat long without arm (5)

Brandon

Width arms: 30 cm
Height legs: 5 cm
Sitting height: ca. 39 cm
Total height: ca. 81 cm
Total depth: ca. 100 cm

Toss cushions 45 x 45 cm:
 Seats with 2 arms: 2x
 Seats with 1 arm/Meridienne/Longchair: 1x



2 arms

Arm L/R

Without arms

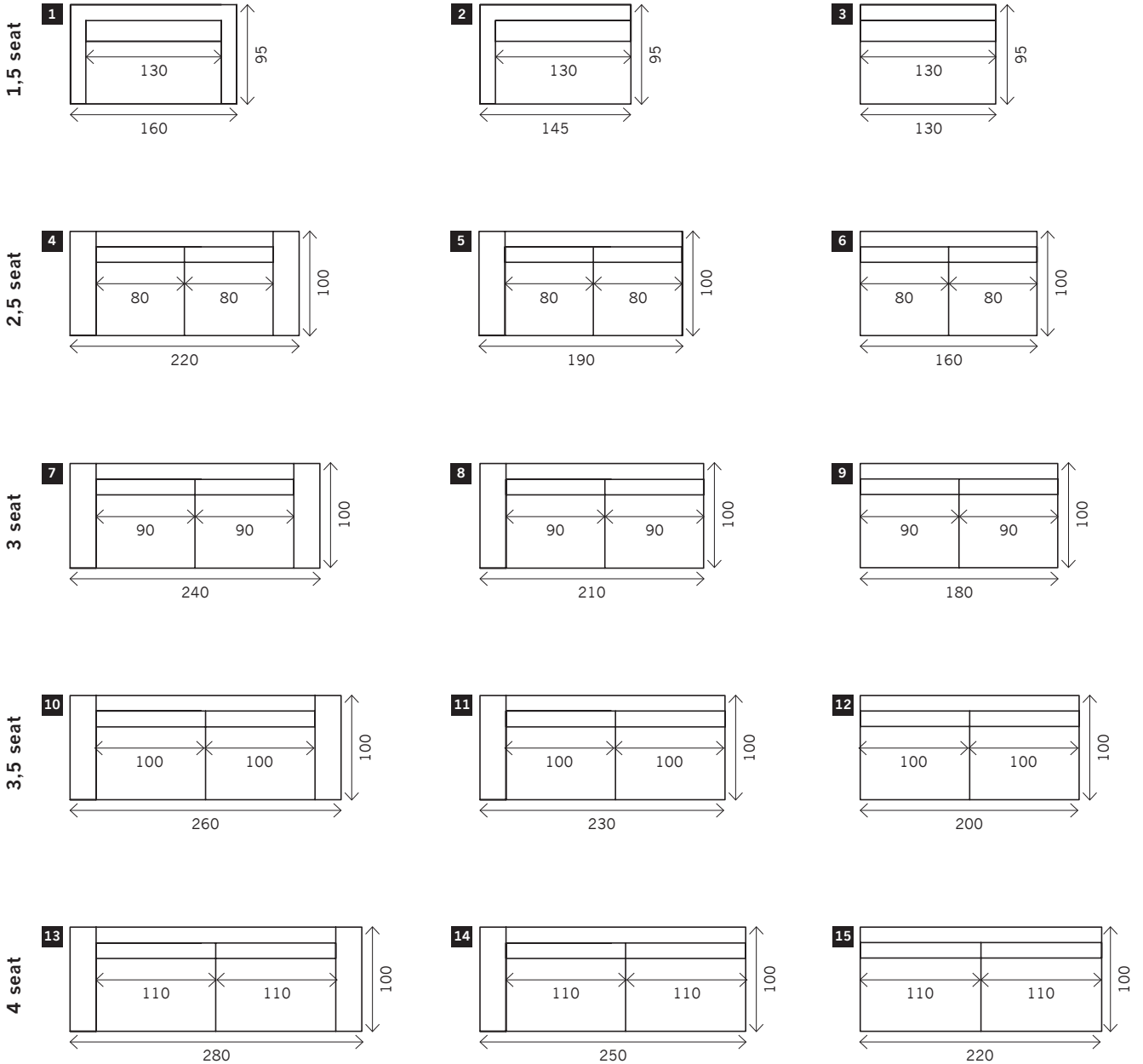

Corner

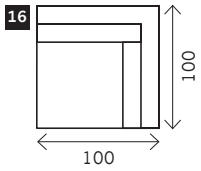

Pouf

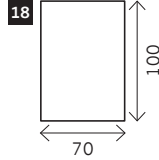
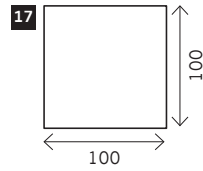

Meridienne L/R

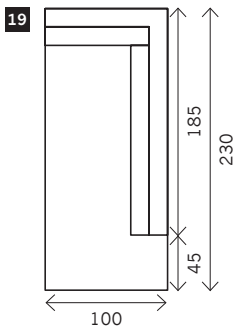

Longchair L/R

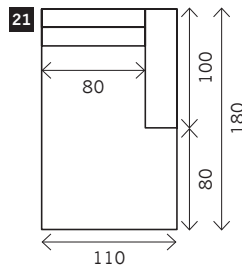
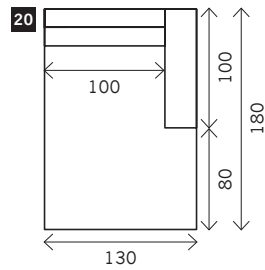

Examples corner sofas

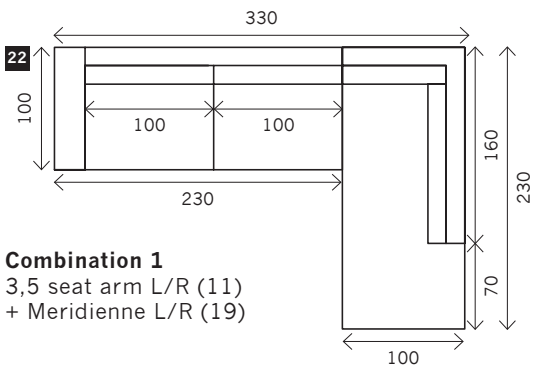

Combination 1
3,5 seat arm L/R (11)
+ Meridienne L/R (19)

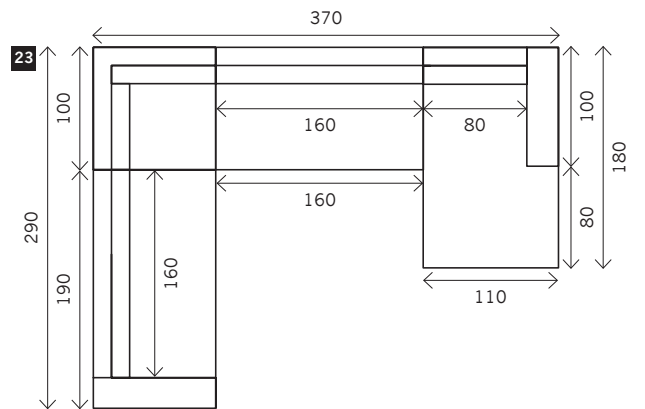

Combination 3
2,5 seat arm L/R (5)
+ Corner (16)
+ 2,5 seat without arms (6)
+ Longchair L/R (20)

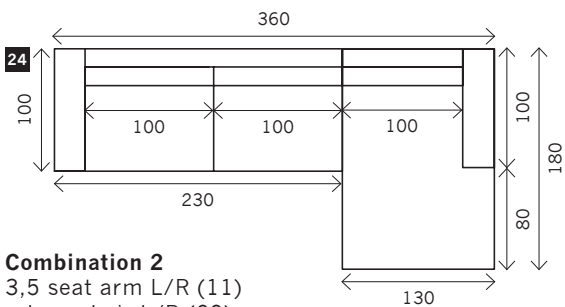

Combination 2
3,5 seat arm L/R (11)
+ Longchair L/R (20)

Champ

Width arms: 17 cm

Height legs: 8 cm

Sitting height: ca. 43 cm

Total height: ca. 80 cm

Total depth: ca. 105 cm

Back cushions 60 x 60 cm:

3 seat: 4x

4 seat, 5 seat: 5x

With skirt

(no legs visible)



2 arms

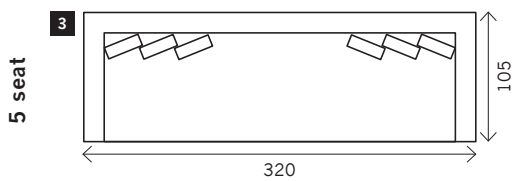
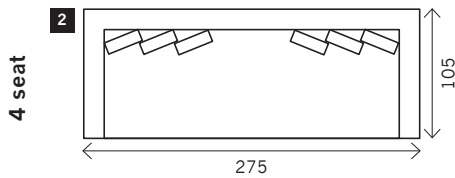
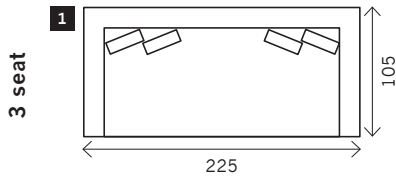

Pouf

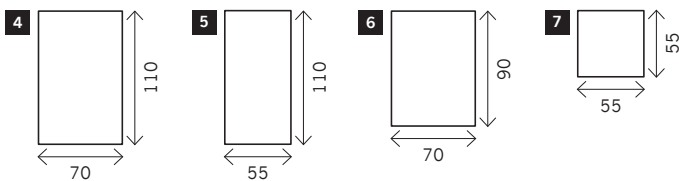

Cibeau

Width arms: 18 cm

Height legs: 5 cm

Sitting height: ca. 42 cm

Total height: ca. 93 cm

Total depth: ca. 100 cm

Legs: black metal

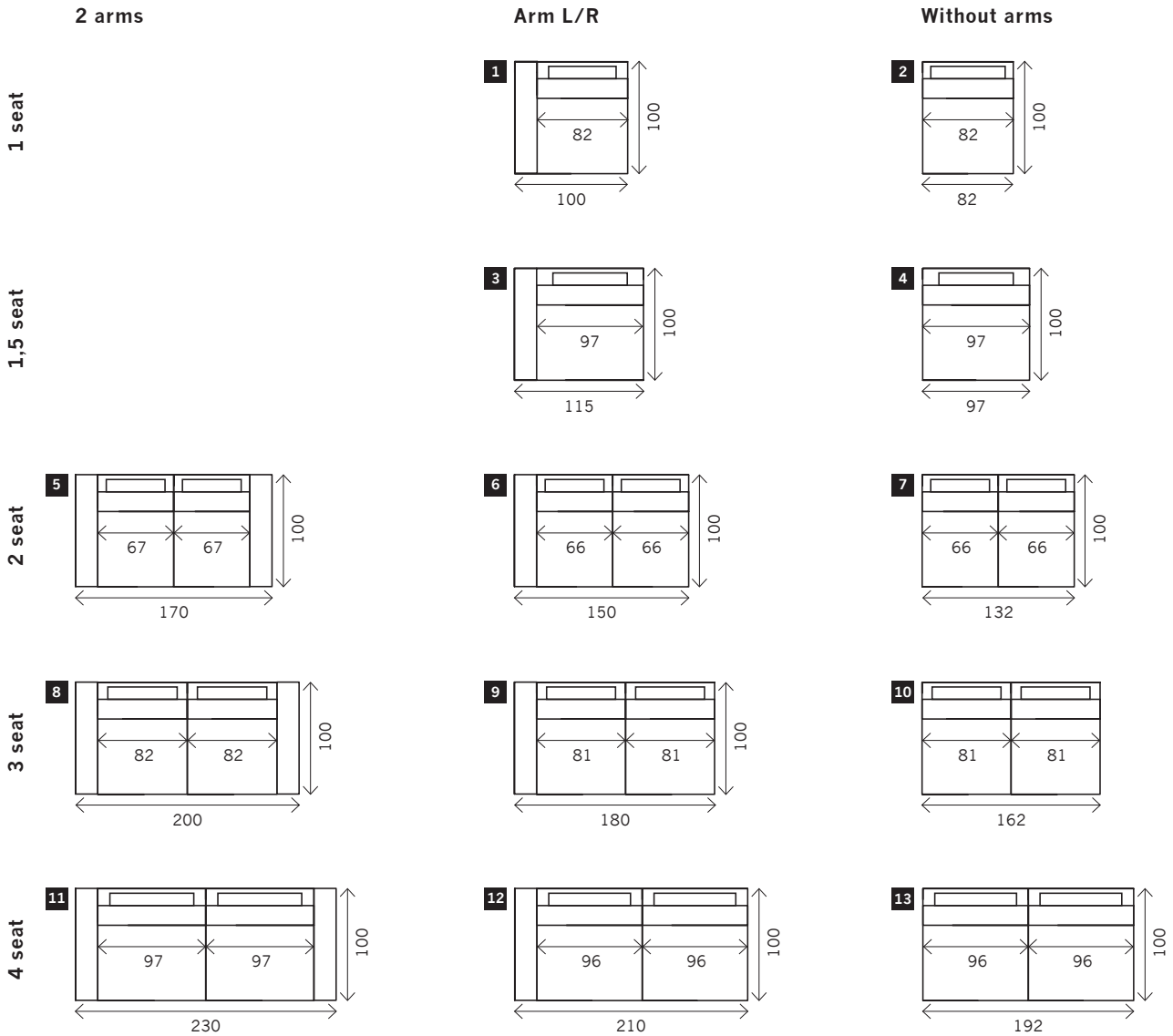

Corner

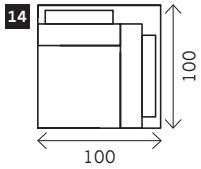

Pouf

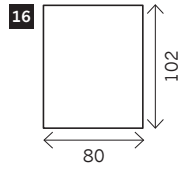
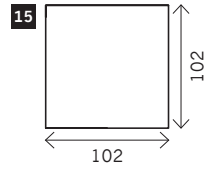

Longchair L/R

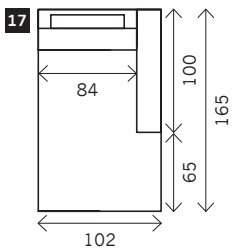

Examples corner sofas

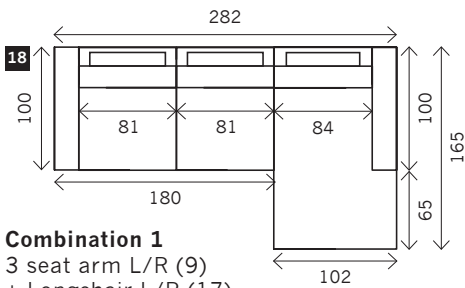

Combination 1
3 seat arm L/R (9)
+ Longchair L/R (17)

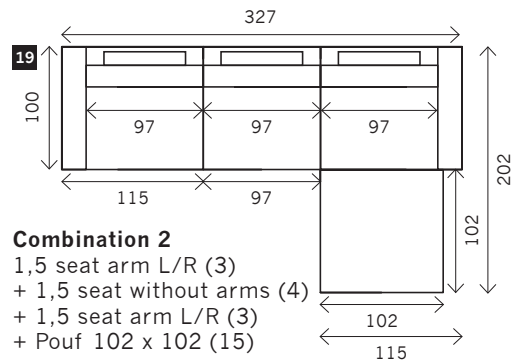

Combination 2
1,5 seat arm L/R (3)
+ 1,5 seat without arms (4)
+ 1,5 seat arm L/R (3)
+ Pouf 102 x 102 (15)

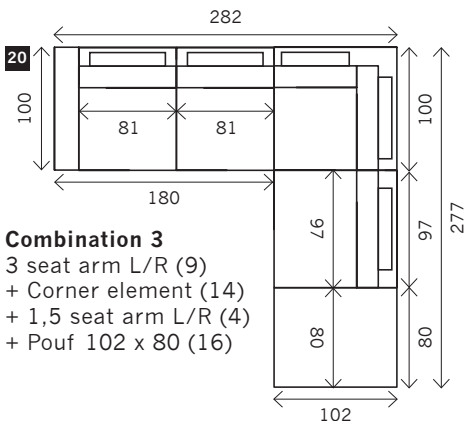

Combination 3
3 seat arm L/R (9)
+ Corner element (14)
+ 1,5 seat arm L/R (4)
+ Pouf 102 x 80 (16)

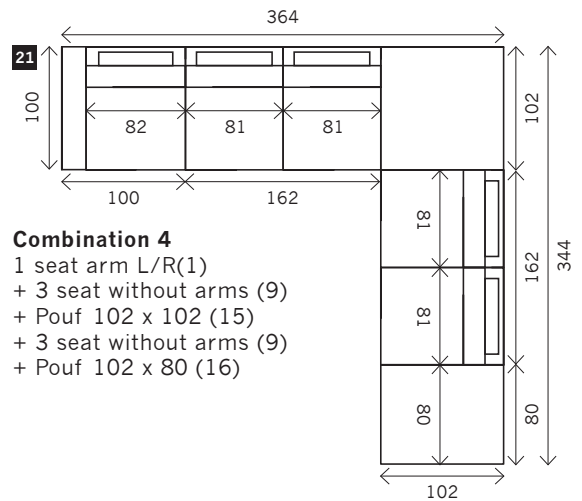

Combination 4
1 seat arm L/R (1)
+ 3 seat without arms (9)
+ Pouf 102 x 102 (15)
+ 3 seat without arms (9)
+ Pouf 102 x 80 (16)

Citizen

Width arms: 15 cm
Height legs: 5 cm
Sitting height: ca. 40 cm
Total height: ca. 80 cm
Total depth: ca. 95 cm

Toss cushions 45 x 45 cm:
 Seats with 2 arms: 2x
 Seats with 1 arm/Meridienne/Longchair: 1x



2 arms

Arm L/R

Without arms

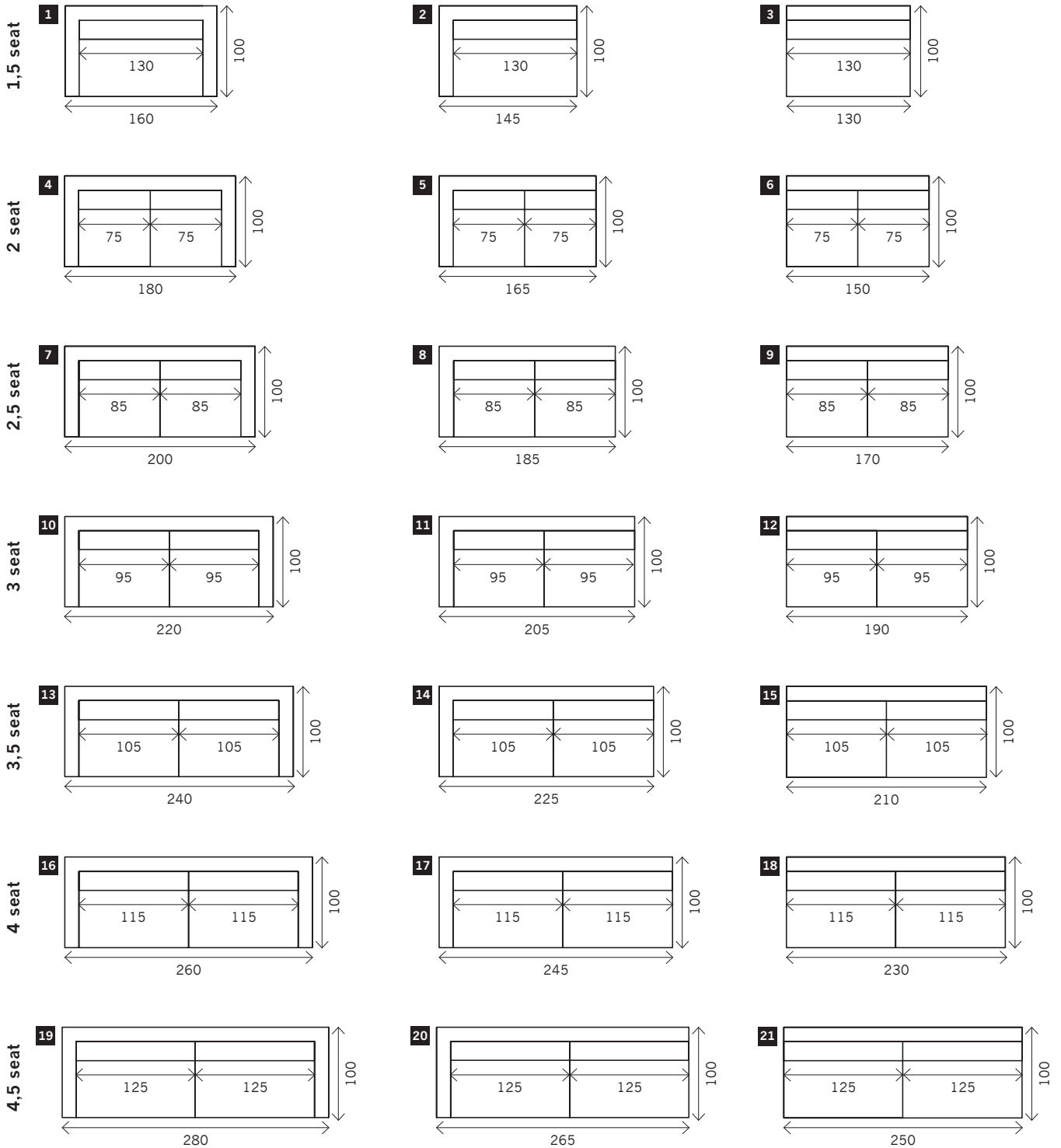

Corner

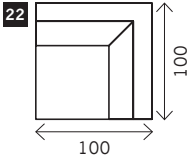

Pouf

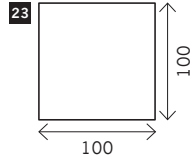

Square:
85 x 85 / 95 x 95
100 x 100 / 105 x 105

Rectangle:
85 x 70 / 95 x 70
105 x 70 / 110 x 65

Cube Lexon

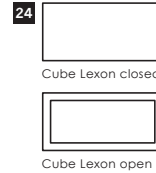

Square:
100 x 100

Rectangle:
50 x 100

Meridienne L/R

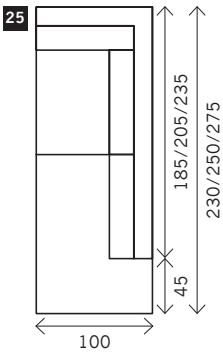

Longchair L/R

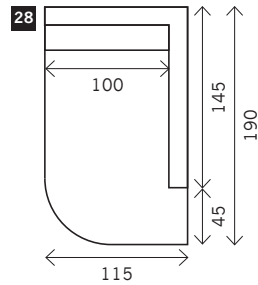
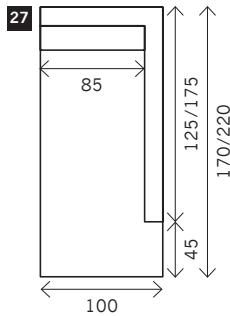
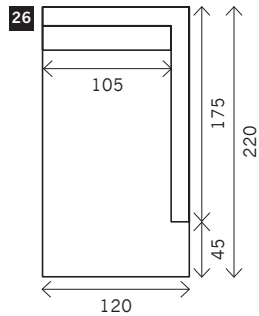

Examples corner sofas

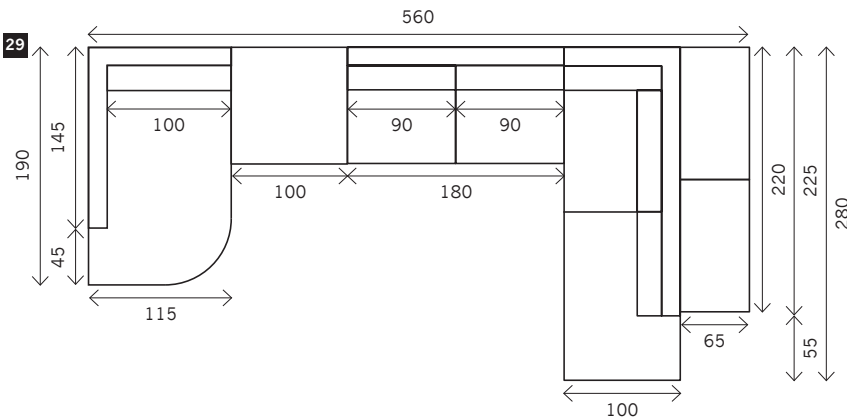

Combination 1
Longchair block arm L/R (28)
+ Cube Lexon closed 100 x 100 (24)
+ 2 seat without arm 180
+ Meridienne 100 x 280
+ 2x Pouf 65 x 110 cm

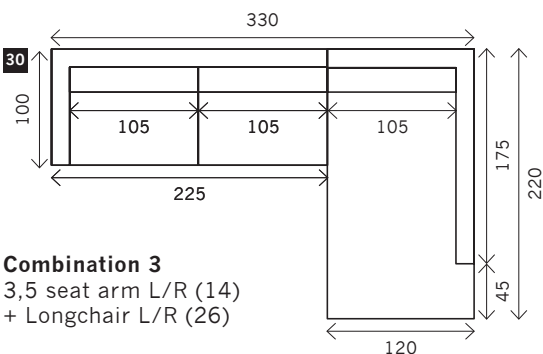

Combination 3
3,5 seat arm L/R (14)
+ Longchair L/R (26)

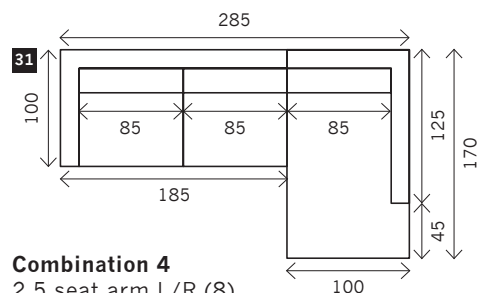

Combination 4
2,5 seat arm L/R (8)
+ Longchair L/R (27)

Dallas

Width arms: 20 cm
Height legs: 4 cm
Sitting height: ca. 44 cm
Total height: ca. 80 cm
Total depth: ca. 98/120 cm

Deep version (120 cm):
 Double row back cushions

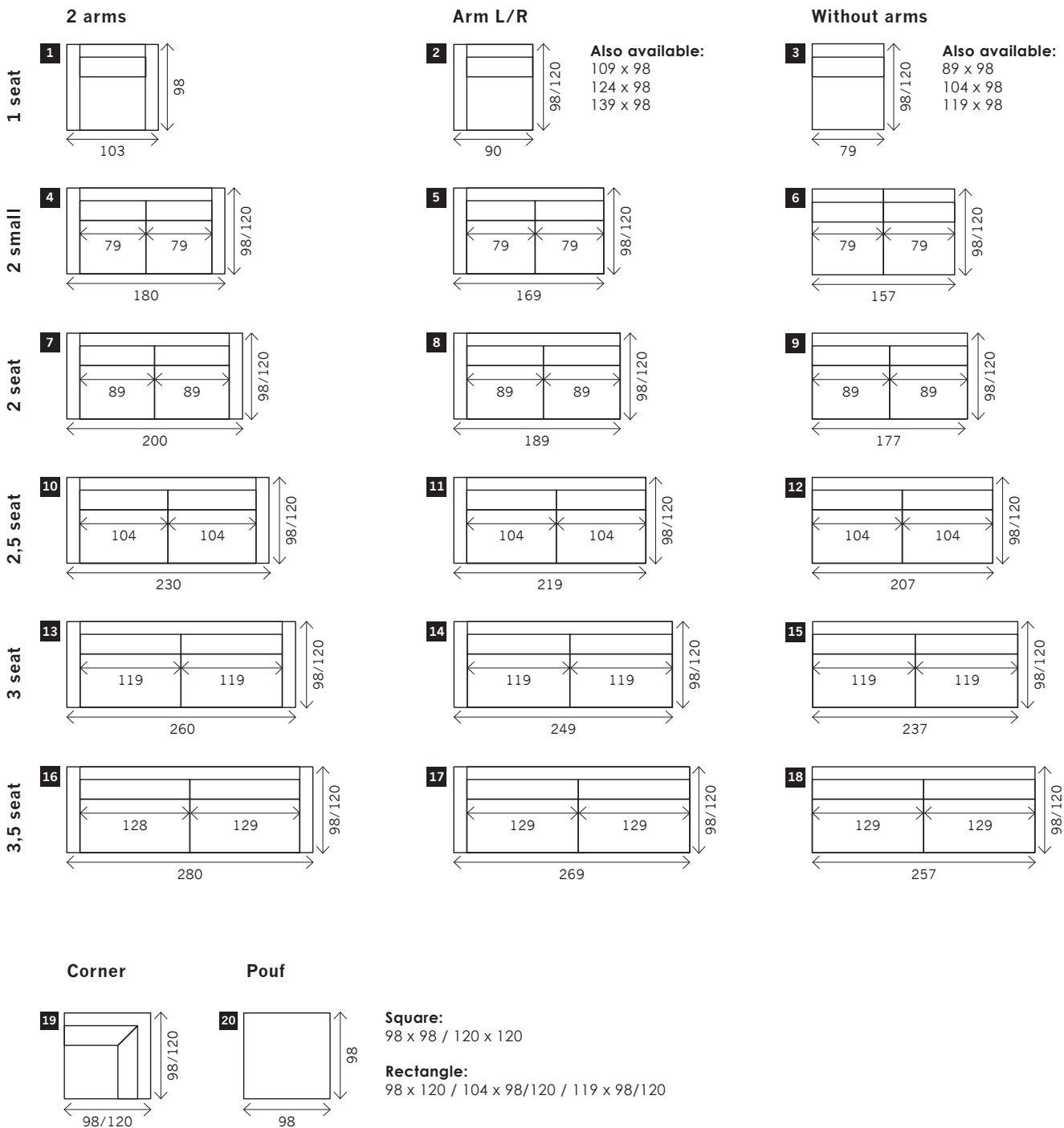

**Terminal special*
with cushion**

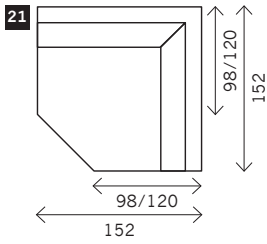

**Terminal special*
without cushion**

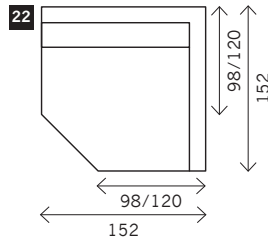

*Possible to create a corner with a combination of the standard version (98 cm) with the deep version (120 cm)

Meridienne L/R

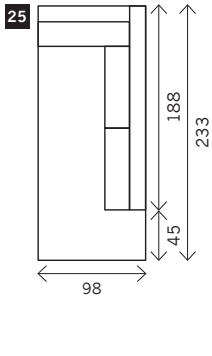
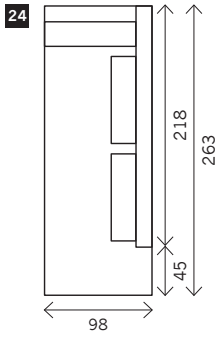
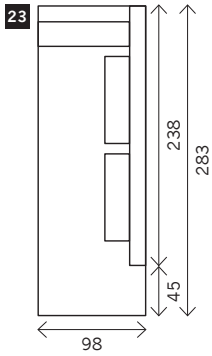

Longchair L/R

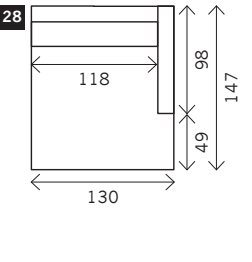
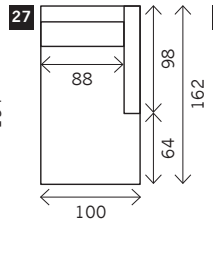
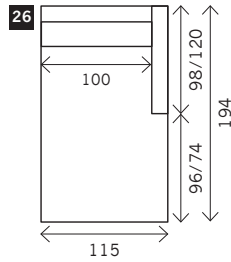

Examples corner sofas

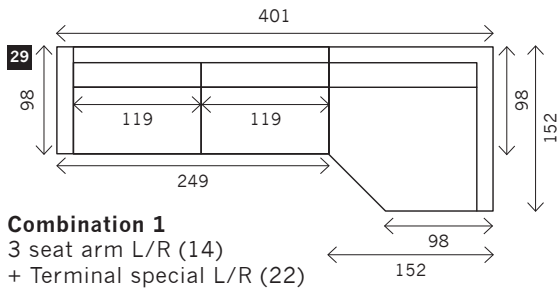

Combination 1
3 seat arm L/R (14)
+ Terminal special L/R (22)

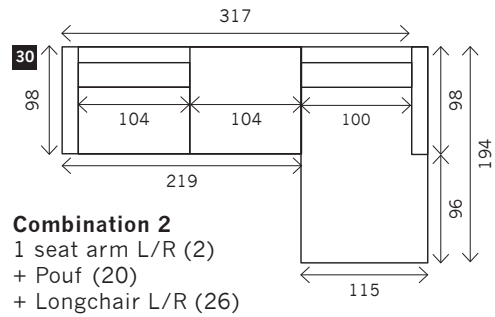

Combination 2
1 seat arm L/R (2)
+ Pouf (20)
+ Longchair L/R (26)

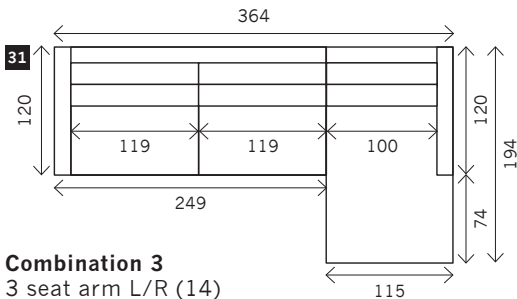

Combination 3
3 seat arm L/R (14)
+ Longchair L/R (26)

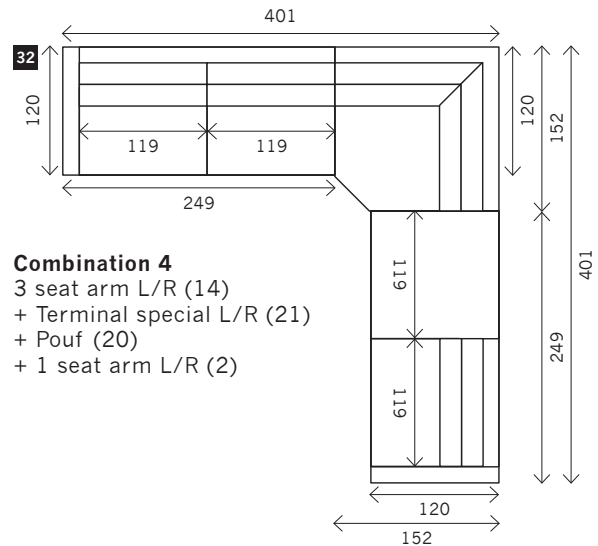

Combination 4
3 seat arm L/R (14)
+ Terminal special L/R (21)
+ Pouf (20)
+ 1 seat arm L/R (2)

Devino

Width arms: 25 cm

Height legs: 4 cm

Sitting height: ca. 48 cm

Total height: ca. 88 cm

Total depth: ca. 98 cm

Toss cushions 45 x 45 cm:

Seats with 2 arms: 2x

Seats with 1 arm/Meridienne/Longchair: 1x



2 arms

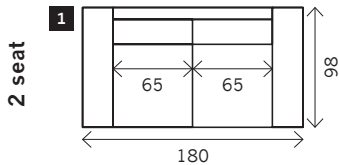

Arm L/R

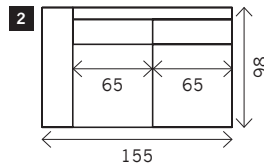

Without arms

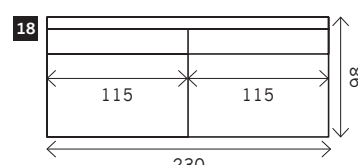
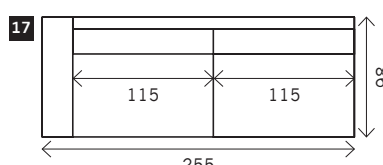
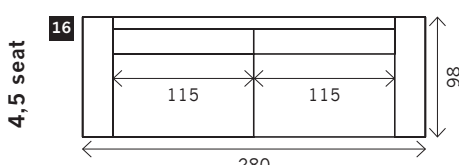
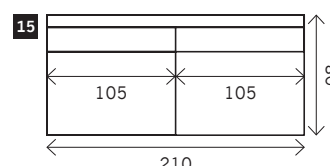
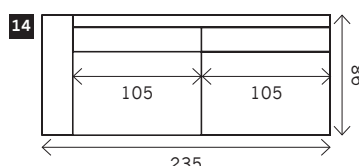
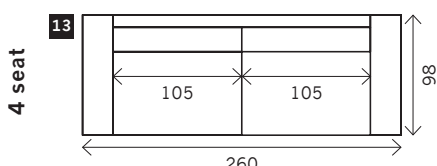
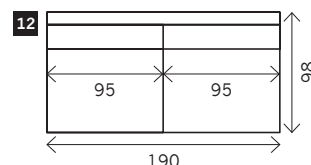
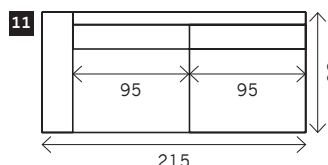
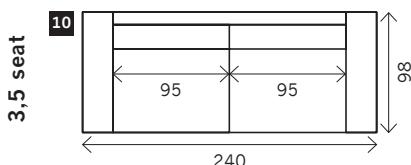
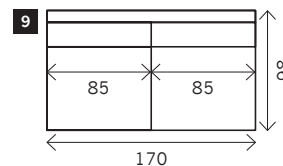
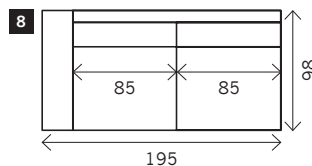
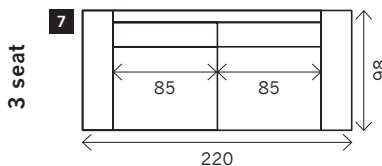
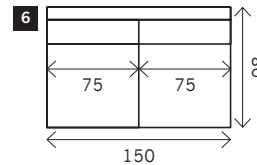
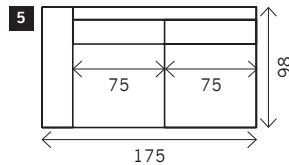
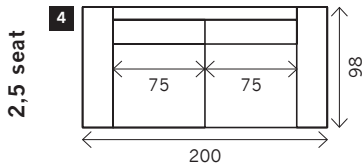
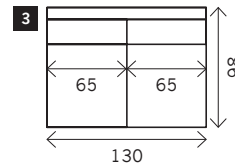

Corner

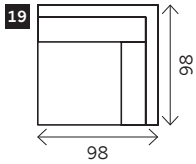

Pouf

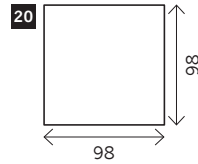

Square:

85 x 85 / 95 x 95 / 105 x 105

Rectangle:

85 x 70 / 95 x 70 / 105 x 70

Meridienne L/R

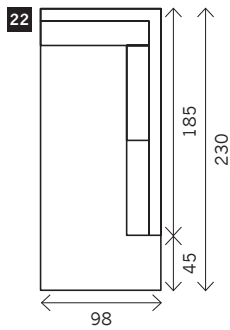
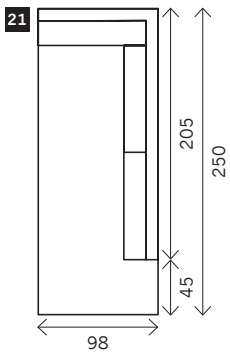

Longchair L/R

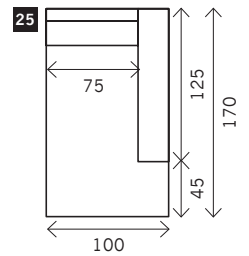
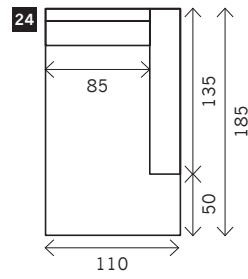
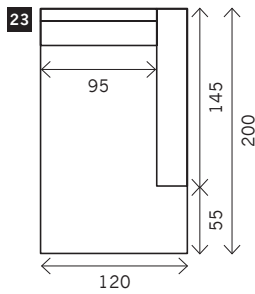

Examples corner sofas

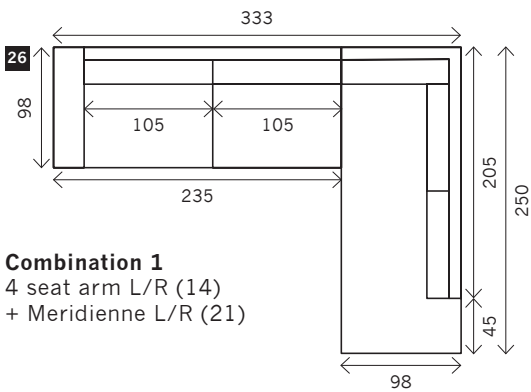

Combination 1
4 seat arm L/R (14)
+ Meridienne L/R (21)

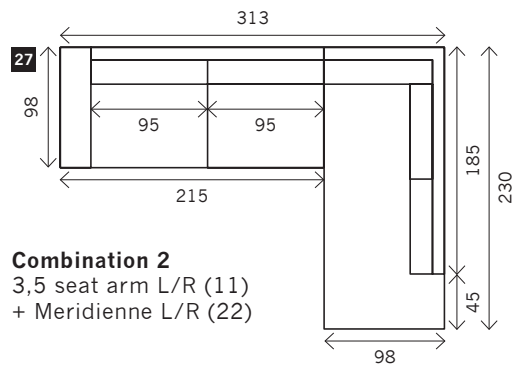

Combination 2
3,5 seat arm L/R (11)
+ Meridienne L/R (22)

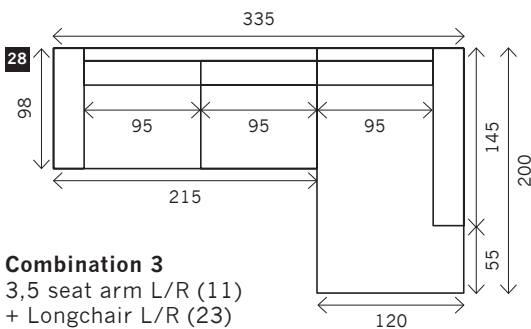

Combination 3
3,5 seat arm L/R (11)
+ Longchair L/R (23)

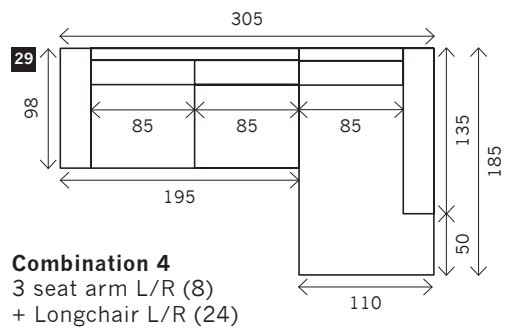

Combination 4
3 seat arm L/R (8)
+ Longchair L/R (24)

Discovery

Width arms: 12 cm
Height legs: 13 cm
Sitting height: ca. 41 cm
Total height: ca. 79 cm
Total depth: ca. 98 cm

Toss cushions 45 x 45 cm:
 Seats with 2 arms: 2x
 Seats with 1 arm/Meridienne/Longchair: 1x
Legs: black metal



2 arms

Arm L/R

Without arms

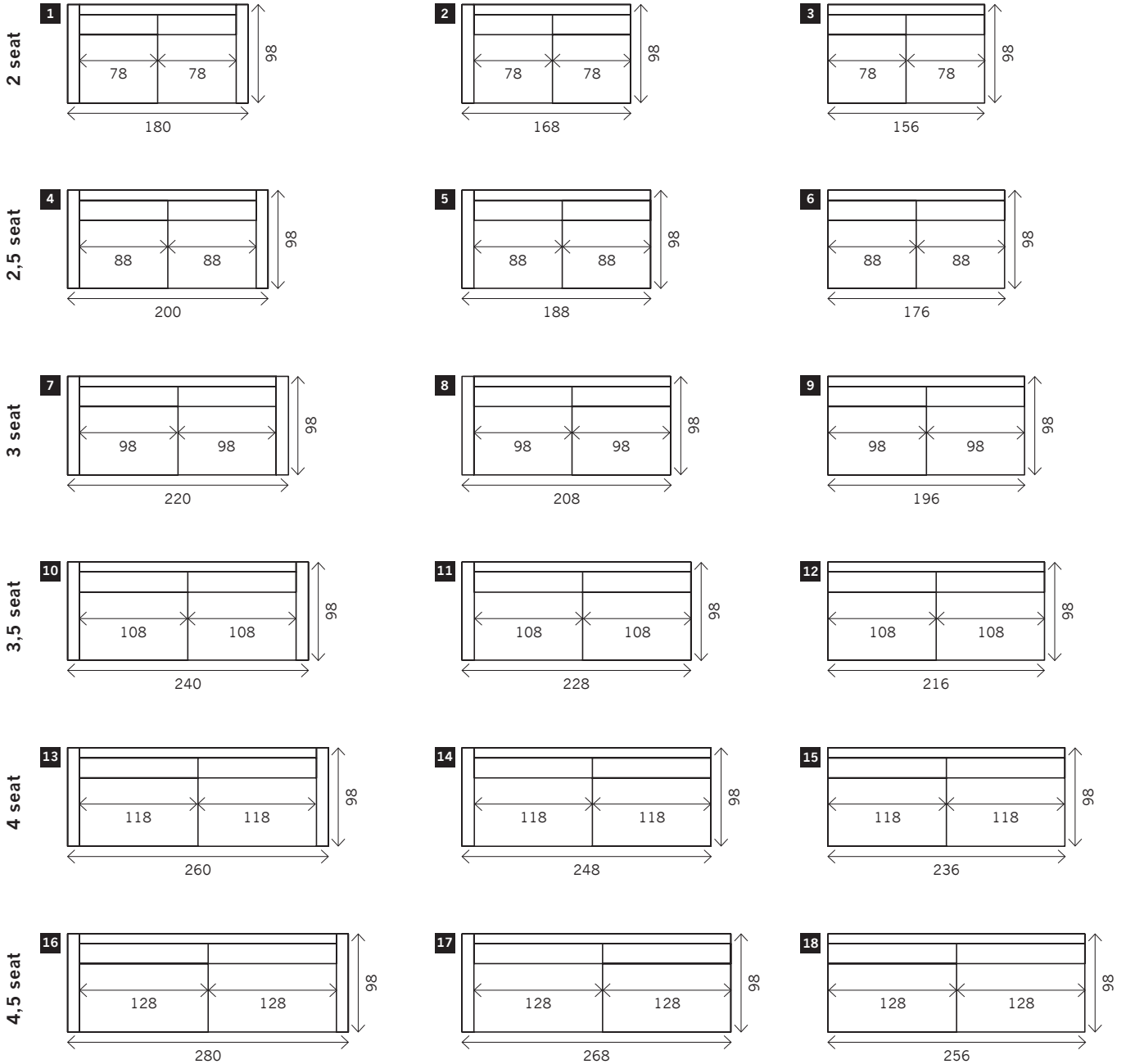

Corner L/R

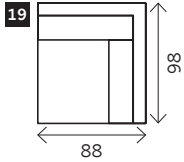

Pouf

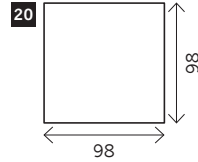

Square:
98 x 98 / 108 x 108

Rectangle:
98 x 70 / 108 x 70

Meridienne L/R

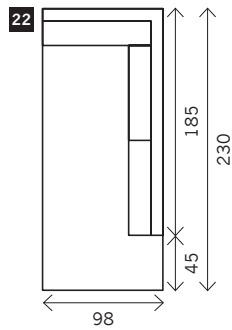
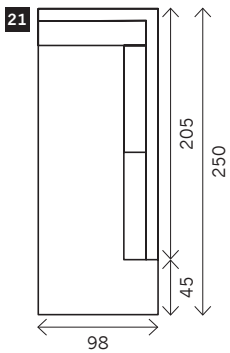

Longchair L/R

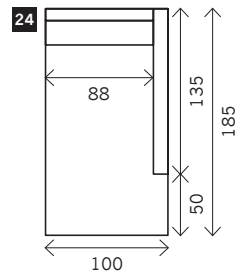
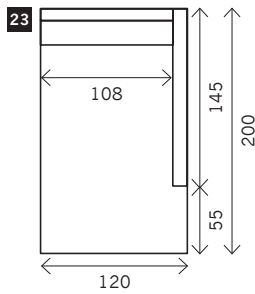

Examples corner sofas

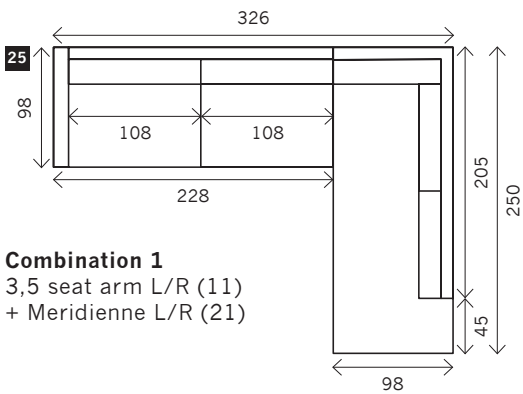

Combination 1
3,5 seat arm L/R (11)
+ Meridienne L/R (21)

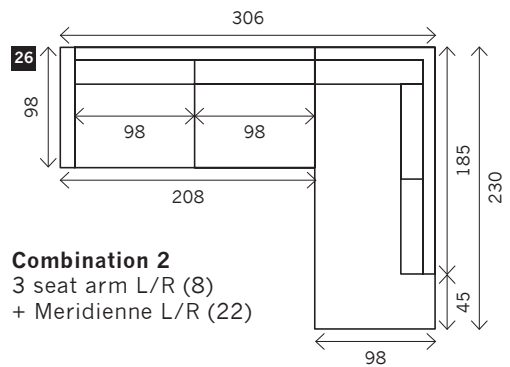

Combination 2
3 seat arm L/R (8)
+ Meridienne L/R (22)

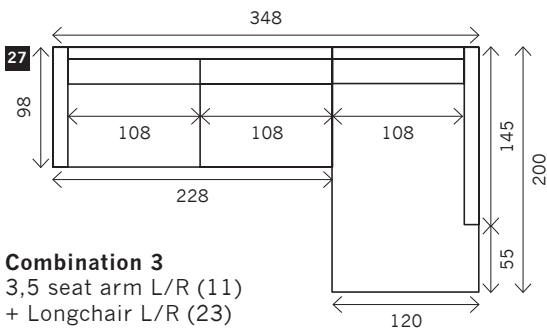

Combination 3
3,5 seat arm L/R (11)
+ Longchair L/R (23)

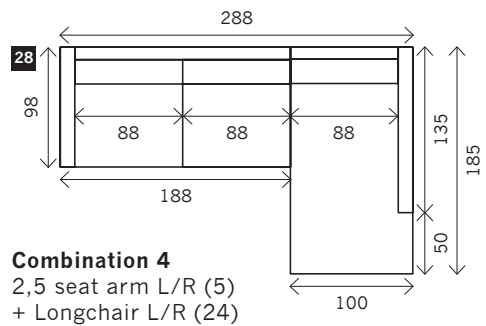

Combination 4
2,5 seat arm L/R (5)
+ Longchair L/R (24)

Durant

Width arms: 16 cm
Height legs: 3 cm
Sitting height: ca. 43 cm
Total height: ca. 84 cm
Total depth: ca. 96 cm



	2 arms	Arm L/R	Without arms
1 seat		1 	2
1,5 seat		3 	4
1,75 seat		5 	6
2 seat	7 	8 	9
3 seat	10 	11 	12
4 seat	13 	14 	15

Corner L/R

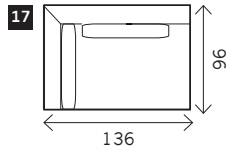
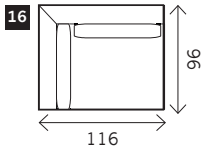

Pouf

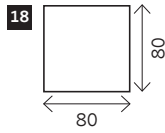

Rectangle:
 45 x 80 / 60 x 80 / 90 x 80
 100 x 80 / 120 x 80

Longchair L/R

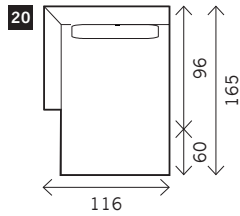
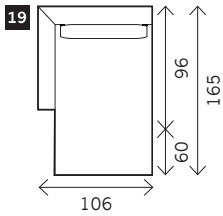

Examples corner sofas

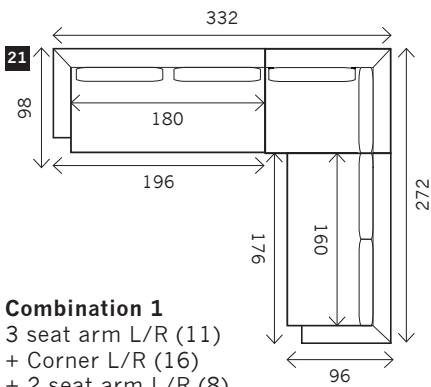

Combination 1
 3 seat arm L/R (11)
 + Corner L/R (16)
 + 2 seat arm L/R (8)

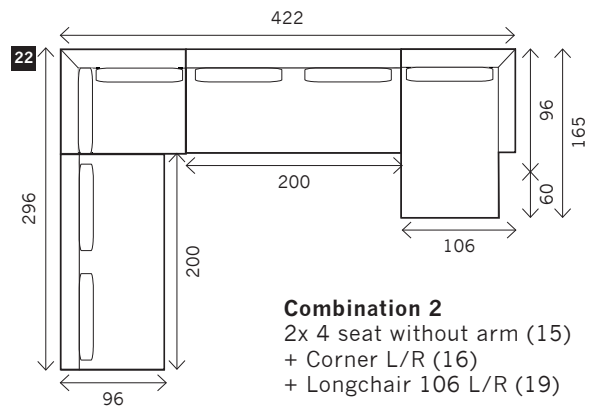

Combination 2
 2x 4 seat without arm (15)
 + Corner L/R (16)
 + Longchair 106 L/R (19)

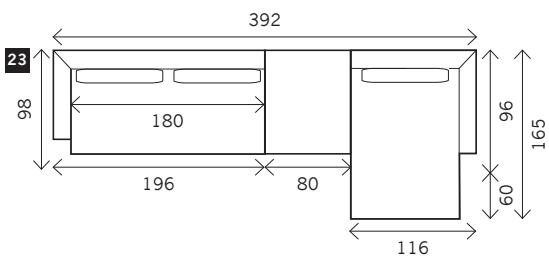

Combination 3
 3 seat arm L/R (11)
 + Pouf (18)
 + Longchair 116 L/R (20)

Gomez

Width arms: 20 cm

Height legs: 13 cm

Sitting height: ca. 43 cm

Total height: ca. 90 cm

Total depth: ca. 101 cm

Legs: black metal



2 arms

Arm L/R

Without arms

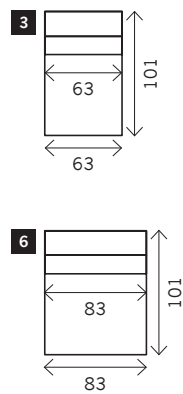
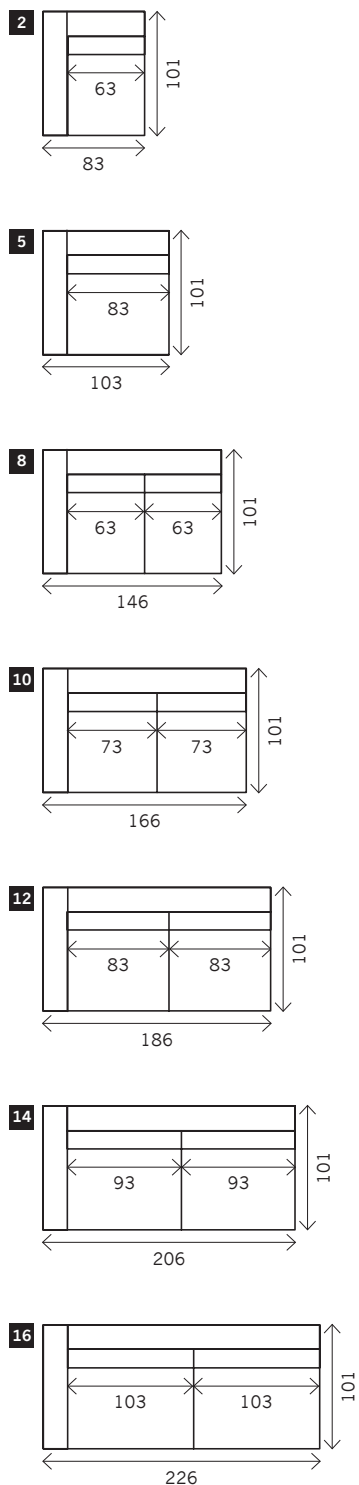
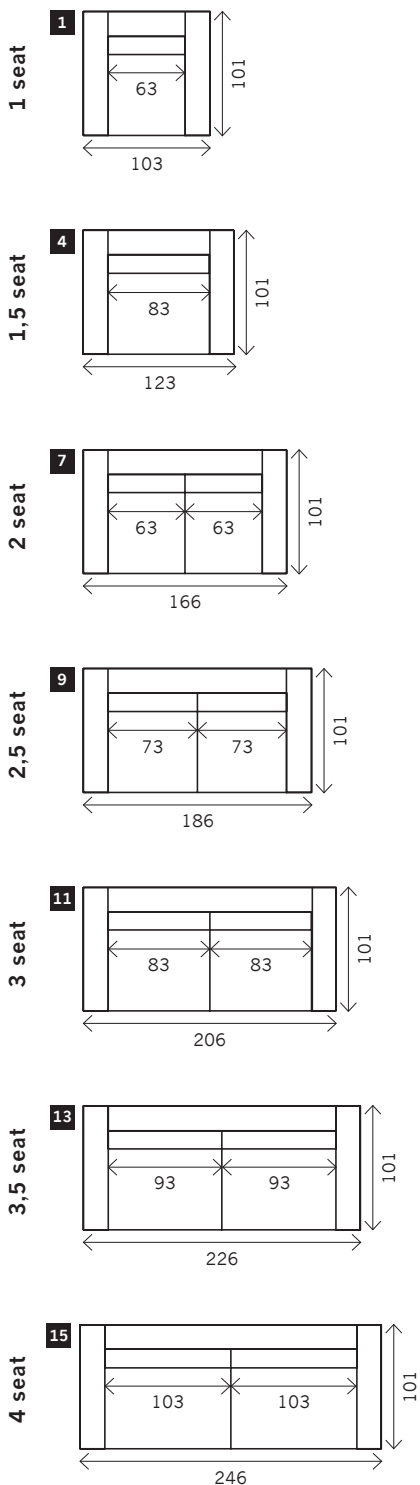

Loveseat

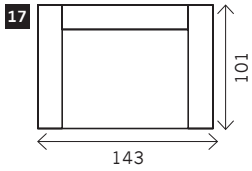

Corner

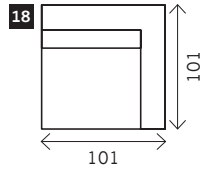

Pouf

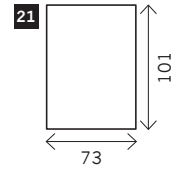
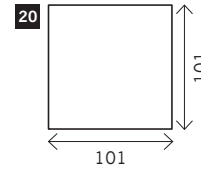
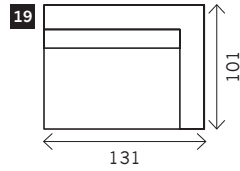

Meridienne L/R

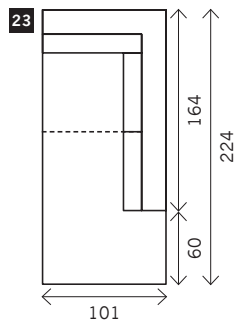
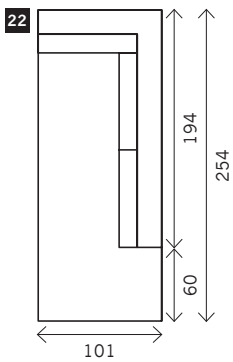

Longchair L/R

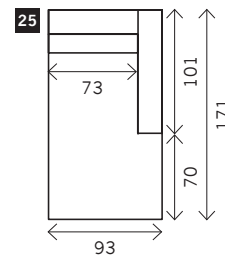
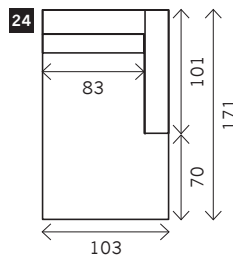

Examples corner sofas

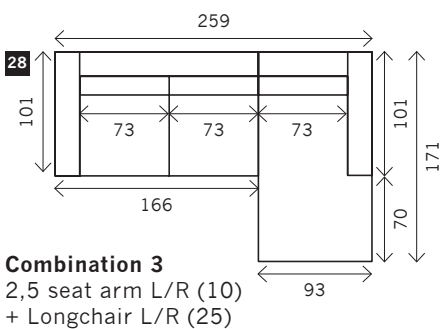
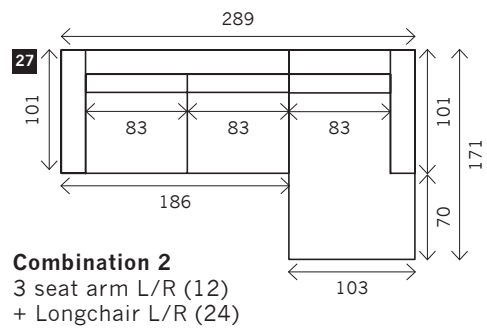
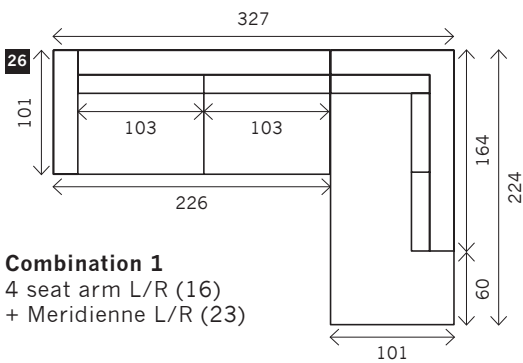

Houston

Width arms: 10 cm
Height legs: 10 cm
Sitting height: ca. 45 cm
Total height: ca. 89 cm
Total depth: ca. 95 cm



2 arms

Arm L/R

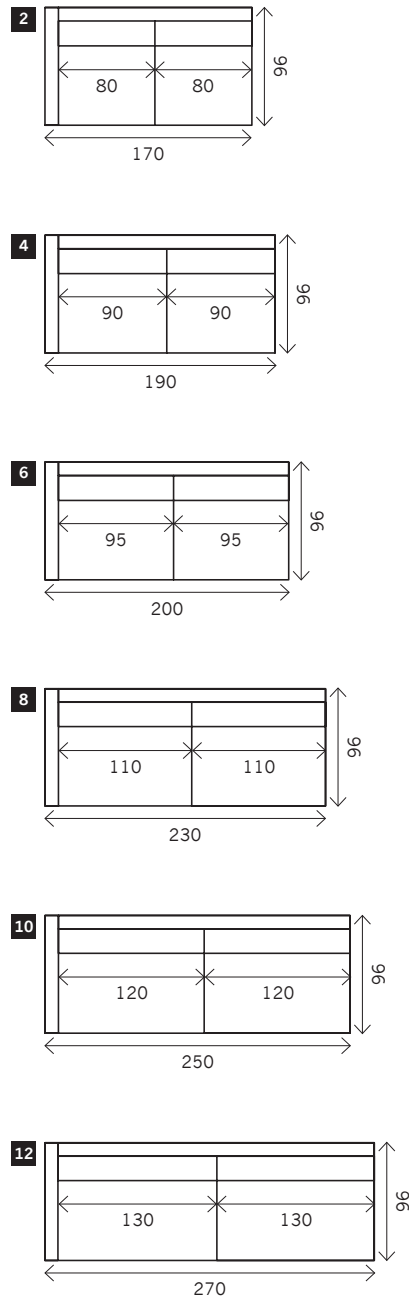
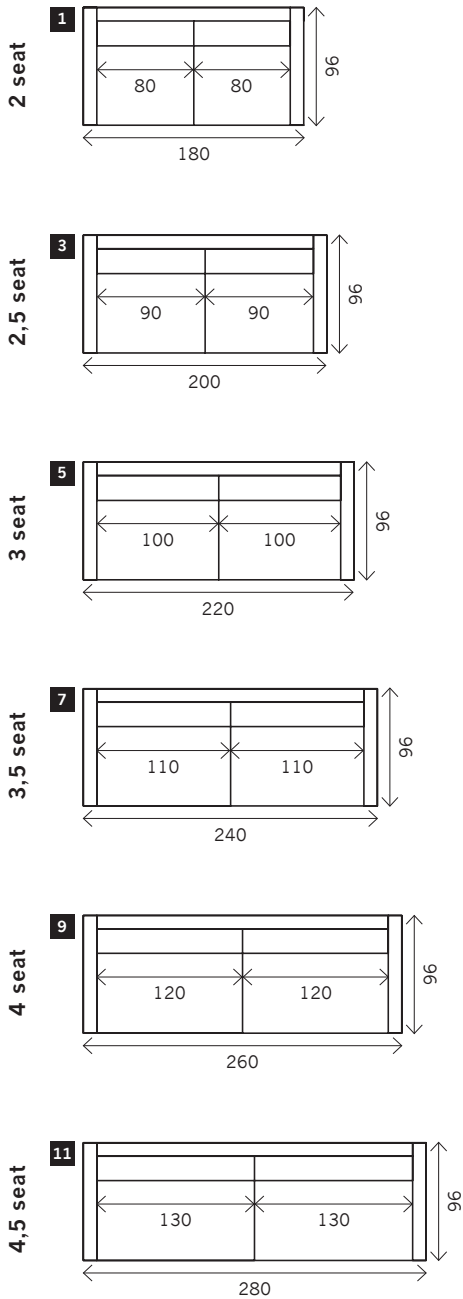

Meridienne L/R

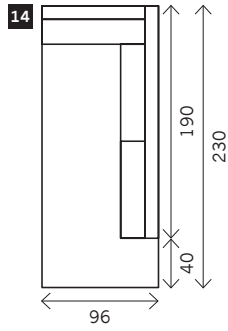
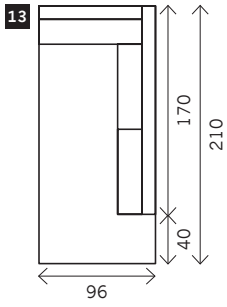

Longchair L/R

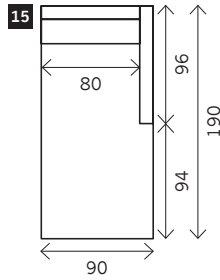

Examples corner sofas

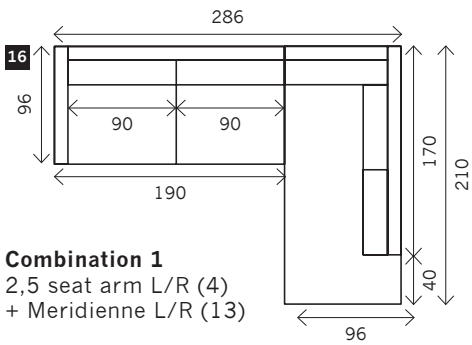

Combination 1
2,5 seat arm L/R (4)
+ Meridienne L/R (13)

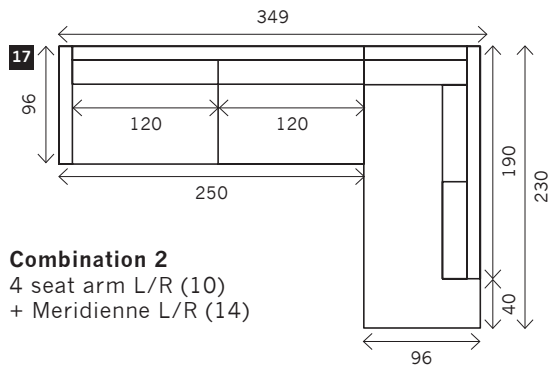

Combination 2
4 seat arm L/R (10)
+ Meridienne L/R (14)

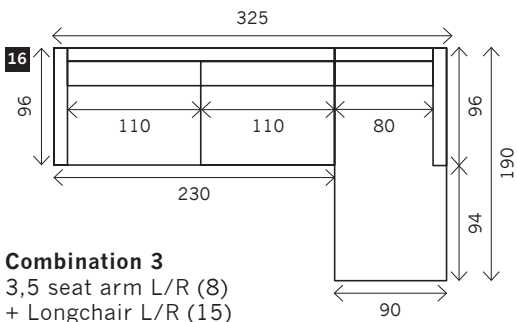

Combination 3
3,5 seat arm L/R (8)
+ Longchair L/R (15)

Juneau

Width arms: 10 cm
Height legs: 4 cm
Sitting height: ca. 45 cm
Total height: 80 cm
Total depth: 105 cm

Back cushions 50 x 50 cm: 2x
Back cushions 60 x 60 cm:
 Fauteuil, 1 seat, 1,5 seat: 1x
 2 seat, 2,5 seat: 3x
 3 seat, 3,5 seat: 4x
 4 seat, 4,5 seat: 5x

With skirt
 (no legs visible)

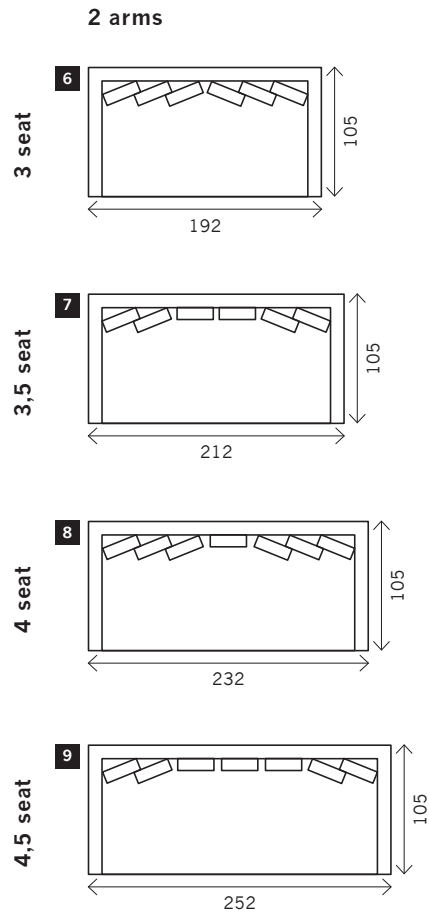
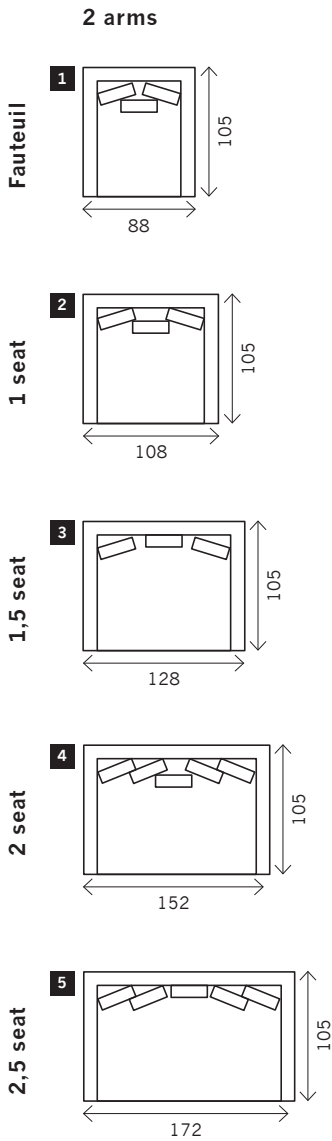

Lars

Width arms: 22 cm B
Height legs: 4 cm H
Sitting height: ca. 43 cm
Total height: 83 cm
Total depth: 100 cm

Toss cushions 45 x 45 cm:
 Seats with 2 arms: 2x
 Seats with 1 arm/Meridienne/Longchair: 1x

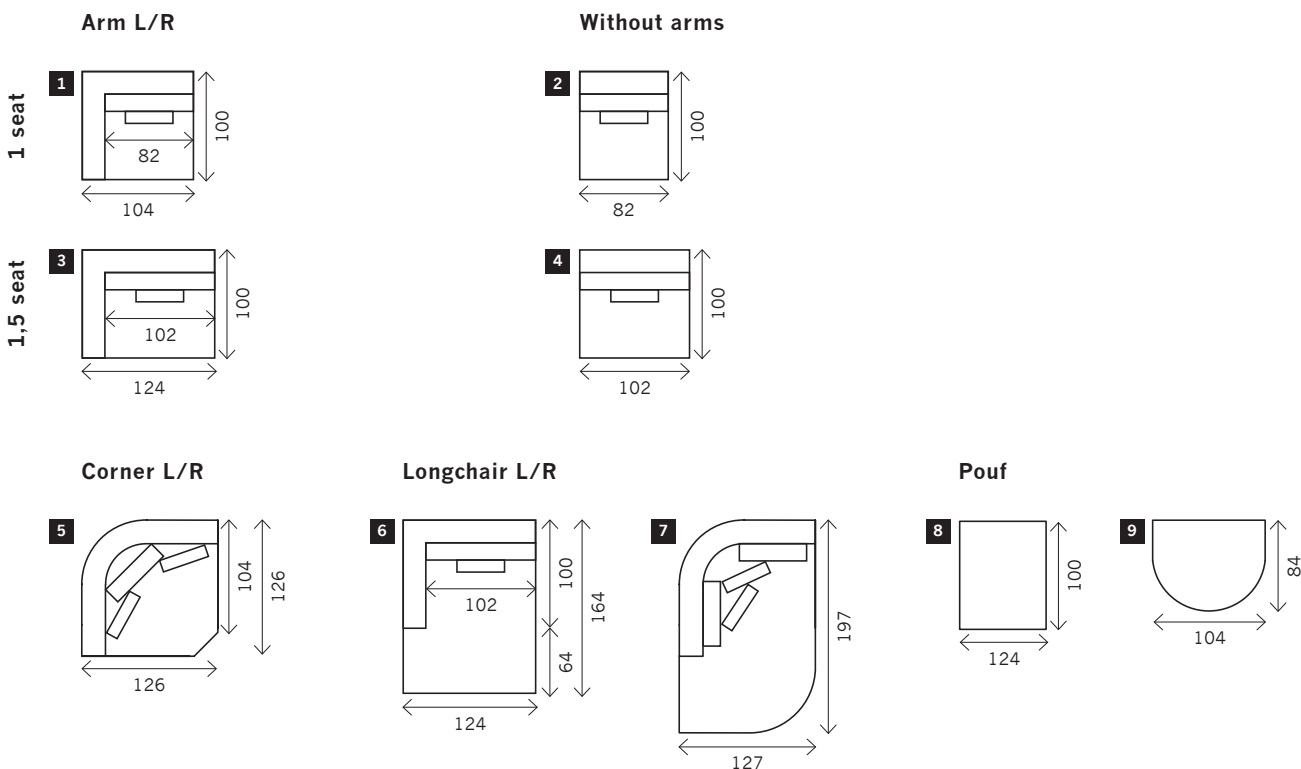

Examples corner sofas

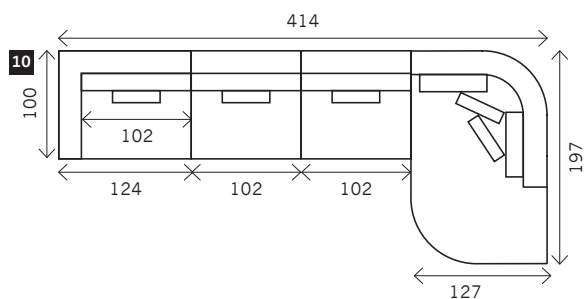

Combination 1
 1,5 seat arm L/R (3)
 + 2x 1,5 seat without arms (4)
 + Longchair round L/R (7)

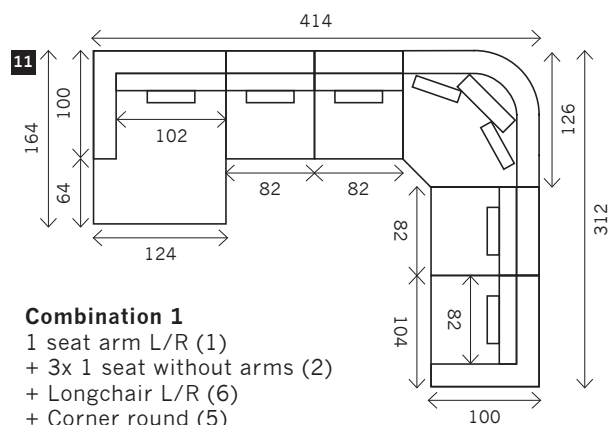

Combination 1
 1 seat arm L/R (1)
 + 3x 1 seat without arms (2)
 + Longchair L/R (6)
 + Corner round (5)

Leonard

Width arms: 13 cm
Height legs: 18 cm
Sitting height: ca. 43 cm
Total height: ca. 89 cm
Total depth: ca. 96 cm

Toss cushions 45 x 45 cm:
 Seats with 2 arms: 2x
 Seats with 1 arm/Meridienne/Longchair: 1x



2 arms

Arm L/R

Without arms

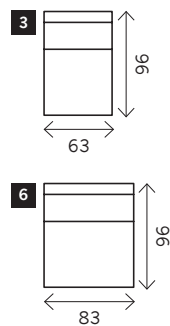
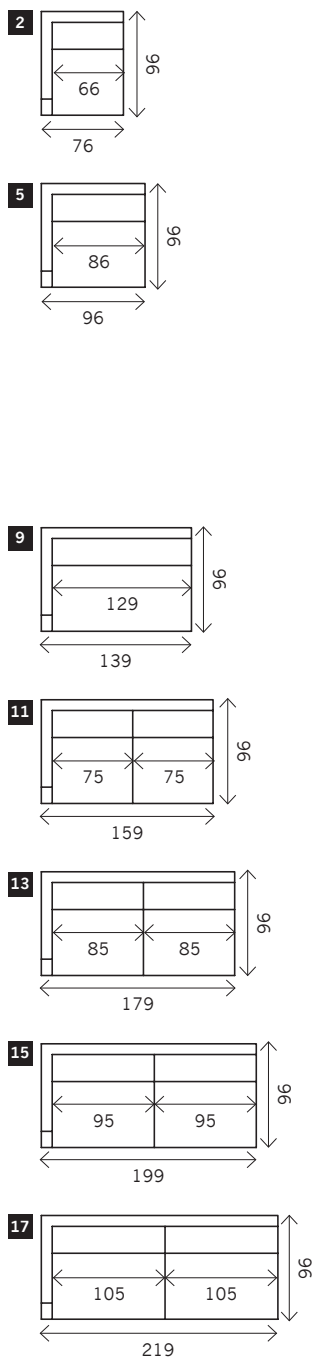
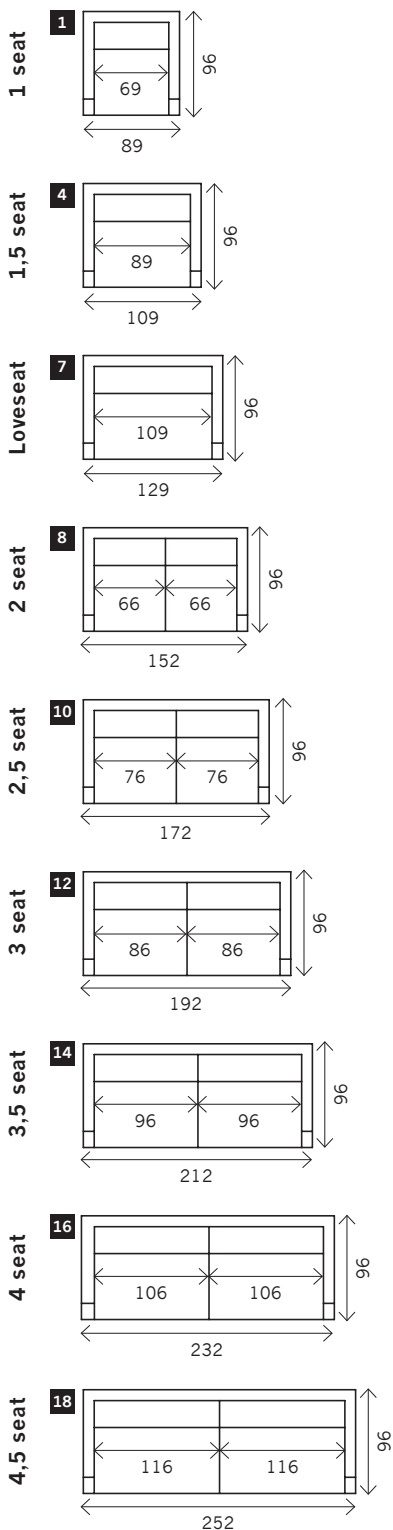

Corner L/R

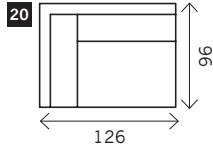
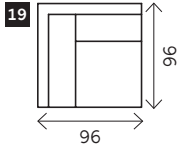

Pouf

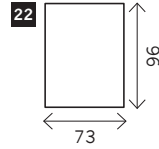
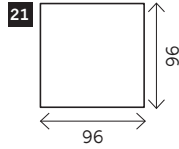

Longchair L/R

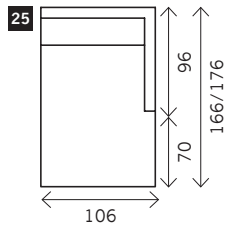
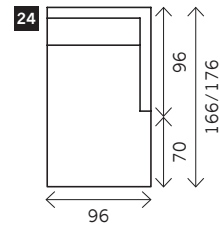
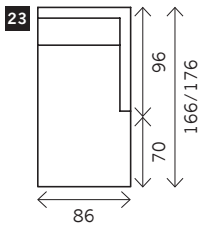

Meridienne L/R

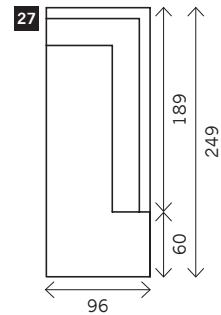
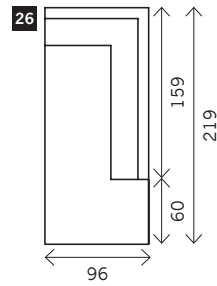

Examples corner sofas

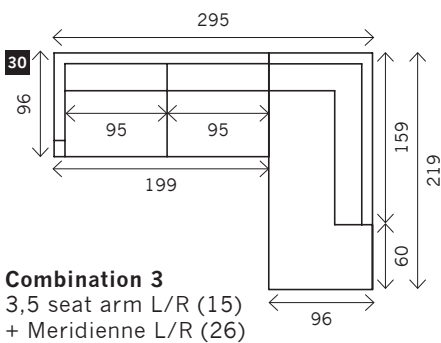
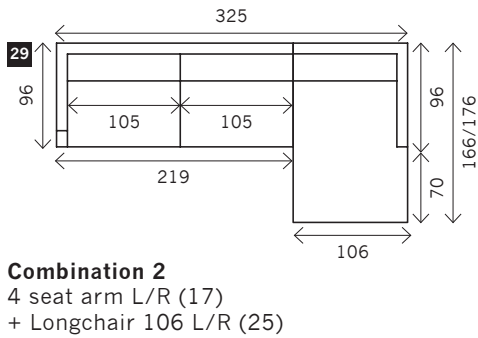
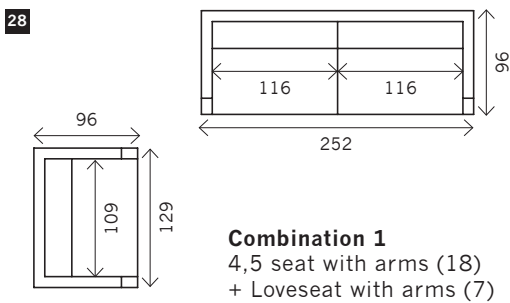

Lou

Width arms: 30 cm
Height legs: 3 cm
Sitting height: ca. 42 cm
Total height: ca. 74 cm
Total depth: ca. 105 cm

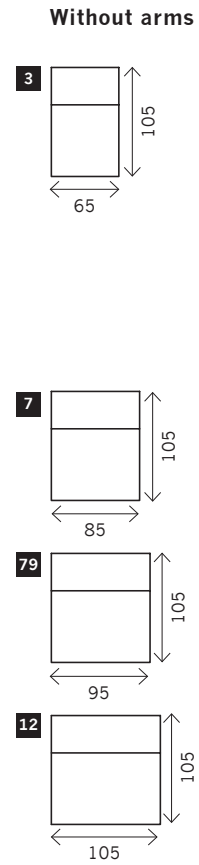
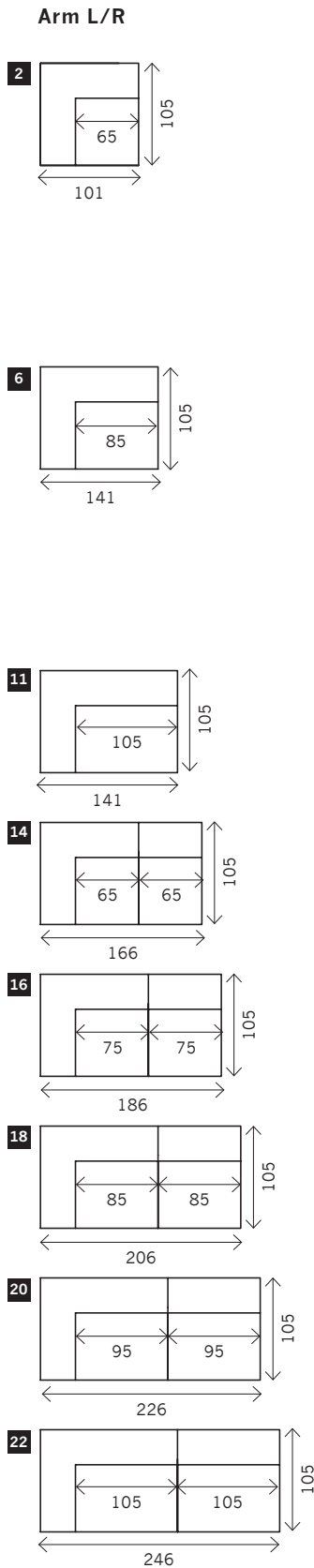
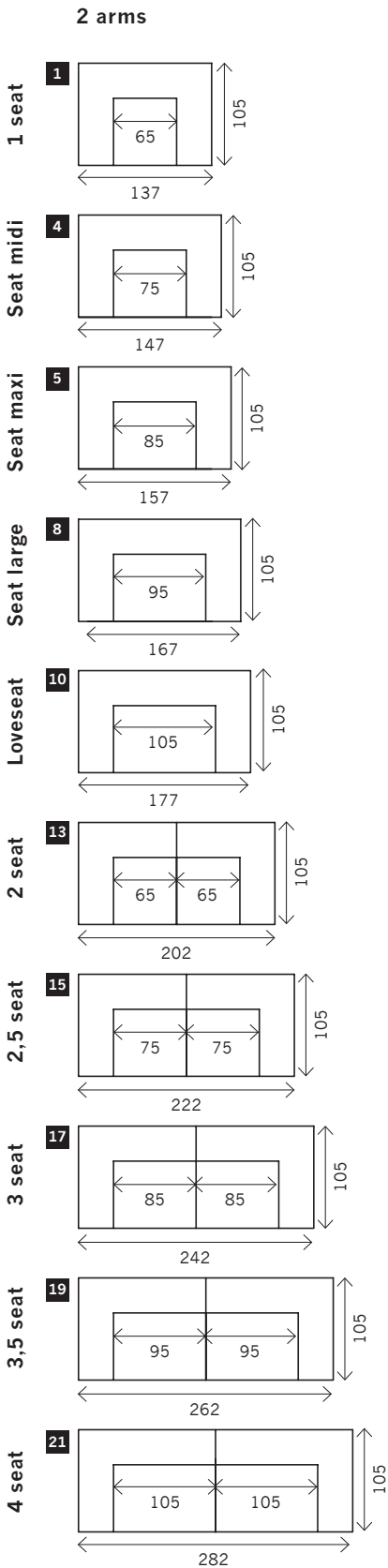

Corner L/R

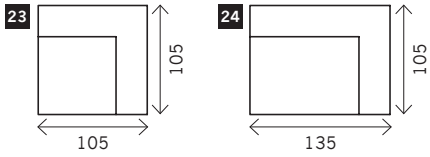

Pouf

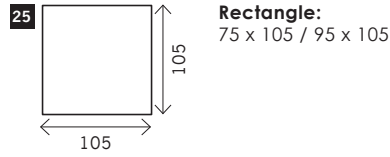

Meridienne L/R

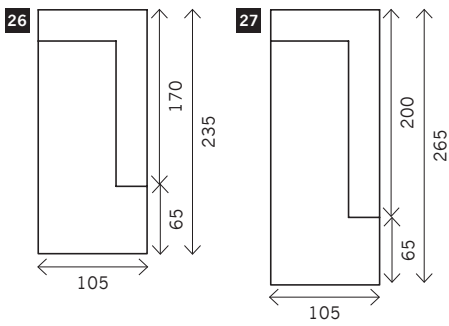

Longchair L/R

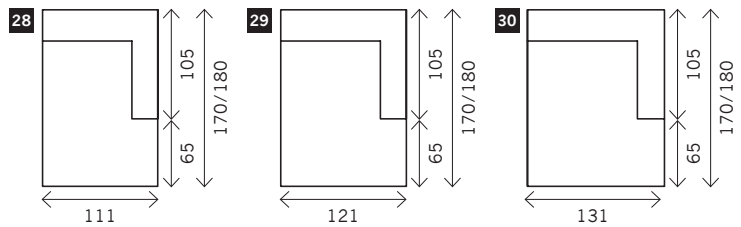

Examples corner sofas

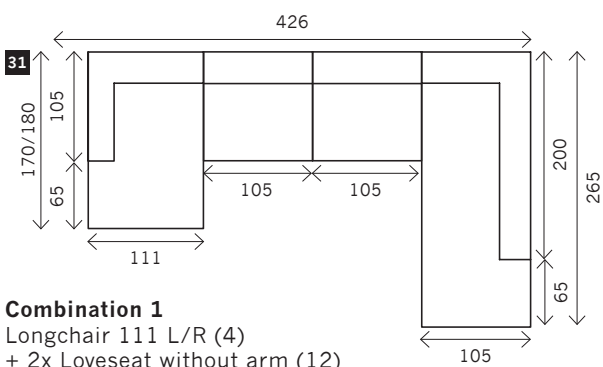

Combination 1

Longchair 111 L/R (4)
+ 2x Loveseat without arm (12)
+ Meridienne L/R (27)

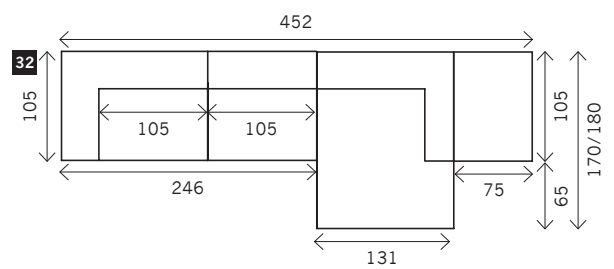

Combination 2

4 seat arm L/R (22)
+ Longchair L/R (30)
+ Pouf (25)

Metropole

Width arms: 25 cm
Height legs: 4 cm
Sitting height: ca. 42 cm
Total height: ca. 80 cm
Total depth: ca. 105 cm

Toss cushions 45 x 45 cm:
 Seats with 2 arms: 2x
 Seats with 1 arm/Meridienne/Longchair: 1x



2 arms

Arm L/R

Without arms

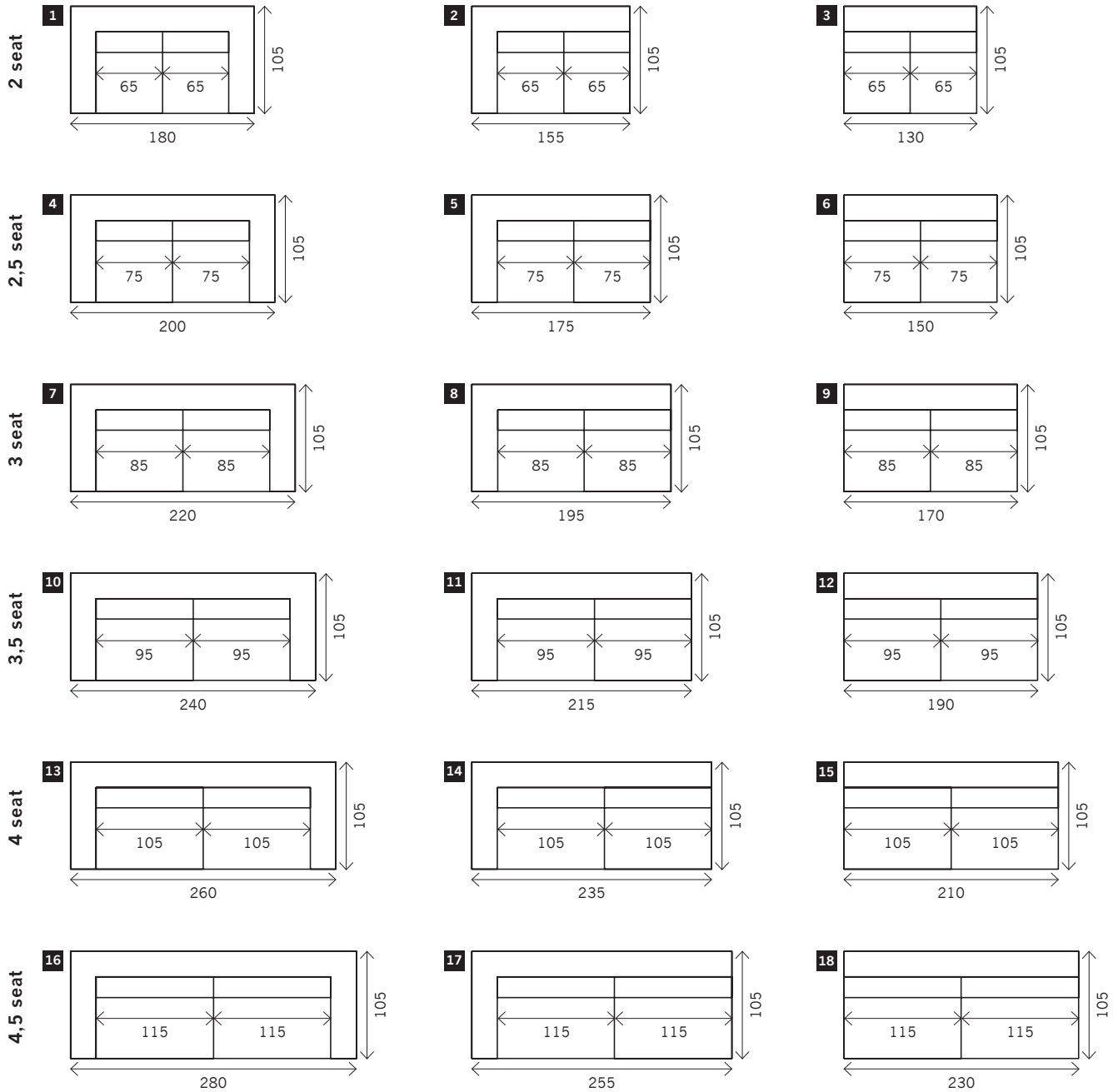

Corner

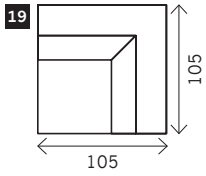

Pouf

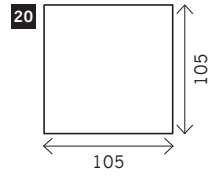

Square:

85 x 85 / 95 x 95 / 105 x 105

Rectangle:

85 x 70 / 95 x 70 / 105 x 70

Meridienne L/R

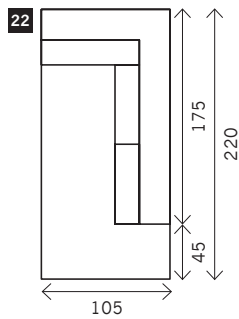
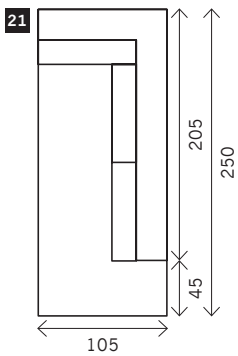

Longchair L/R

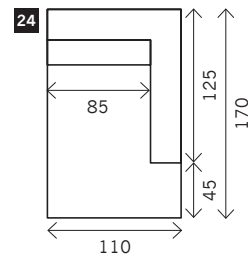
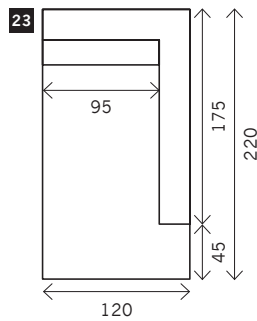

Examples corner sofas

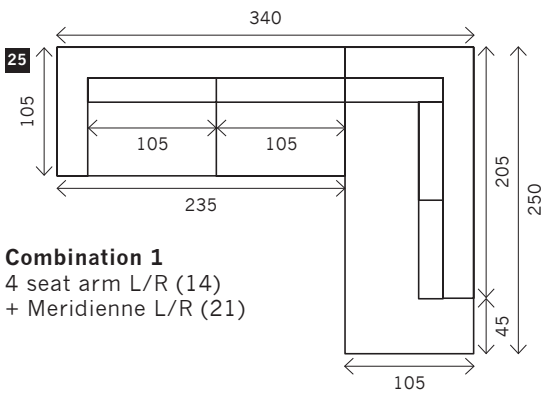

Combination 1

4 seat arm L/R (14)
+ Meridienne L/R (21)

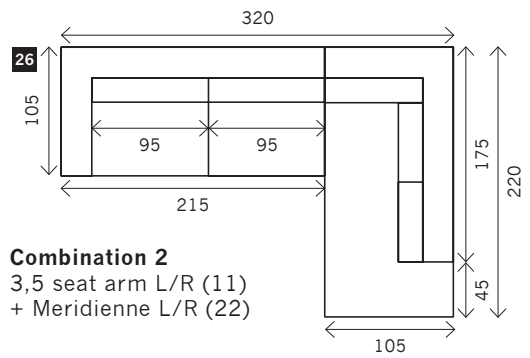

Combination 2

3,5 seat arm L/R (11)
+ Meridienne L/R (22)

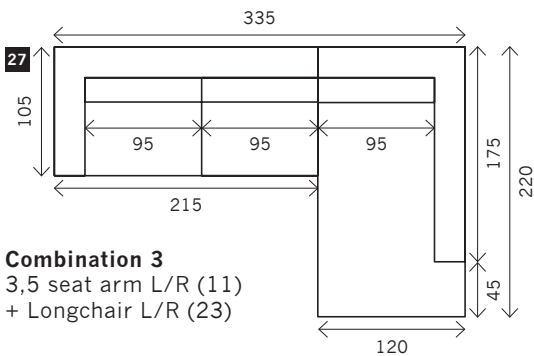

Combination 3

3,5 seat arm L/R (11)
+ Longchair L/R (23)

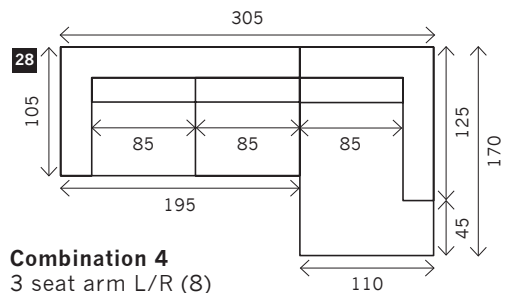

Combination 4

3 seat arm L/R (8)
+ Longchair L/R (24)

Moore

Width arms: 13 cm
Height legs: 15 cm
Sitting height: ca. 45 cm
Total height: ca. 85 cm
Total depth: ca. 96 cm

Toss cushions 45 x 45 cm:
 Seats with 2 arms: 2x
 Seats with 1 arm/Meridienne/Longchair: 1x

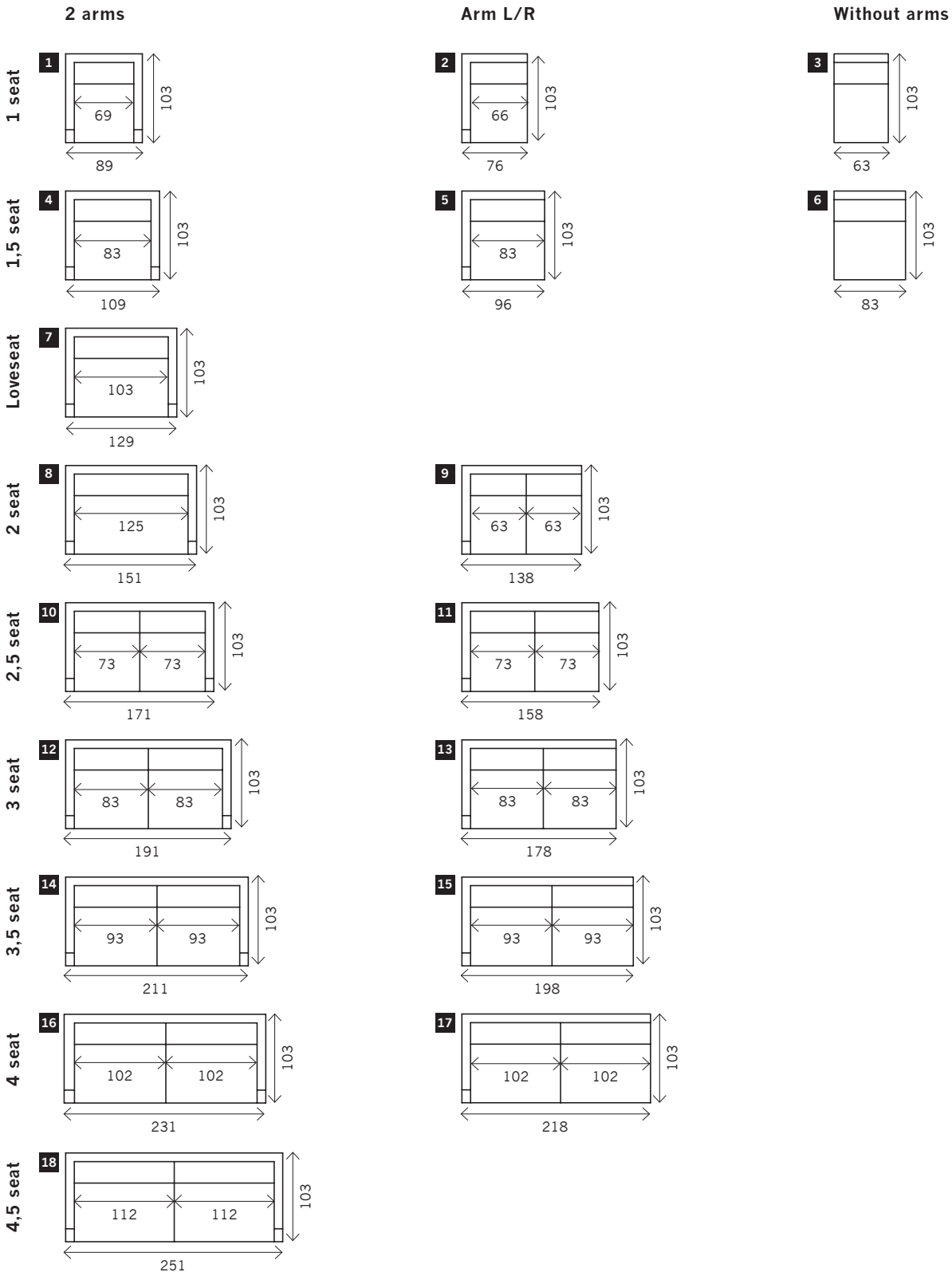

Corner L/R

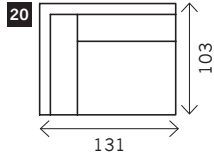
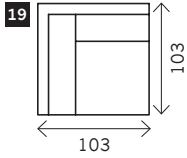

Pouf

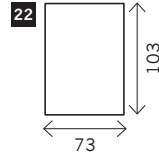
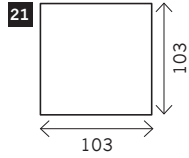

Longchair L/R

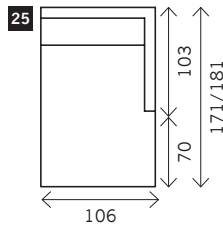
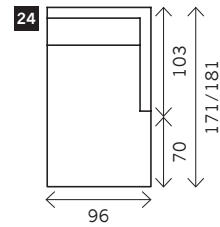
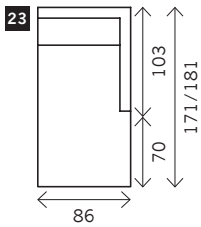

Meridienne L/R

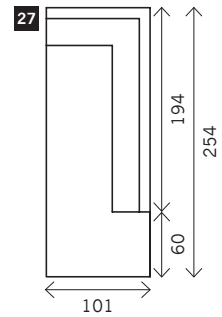
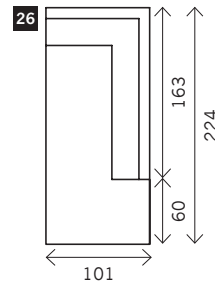

Examples corner sofas

28

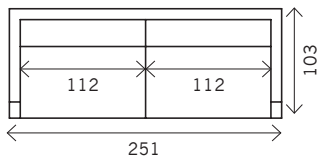
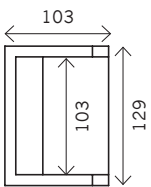

Combination 1
4,5 seat with arms (18)
+ Loveseat with arms (7)

29

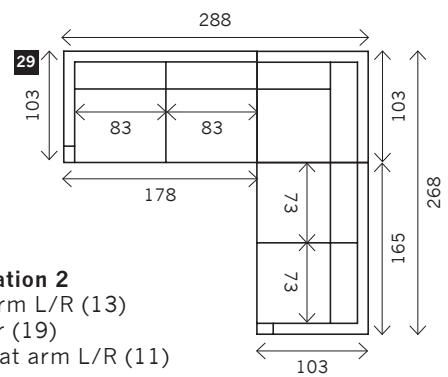

Combination 2
3 seat arm L/R (13)
+ Corner (19)
+ 2,5 seat arm L/R (11)

Nano

Width arms: 18 cm
Height legs: 5 cm
Sitting height: ca. 42 cm
Total height: ca. 77 cm
Total depth: ca. 100 cm

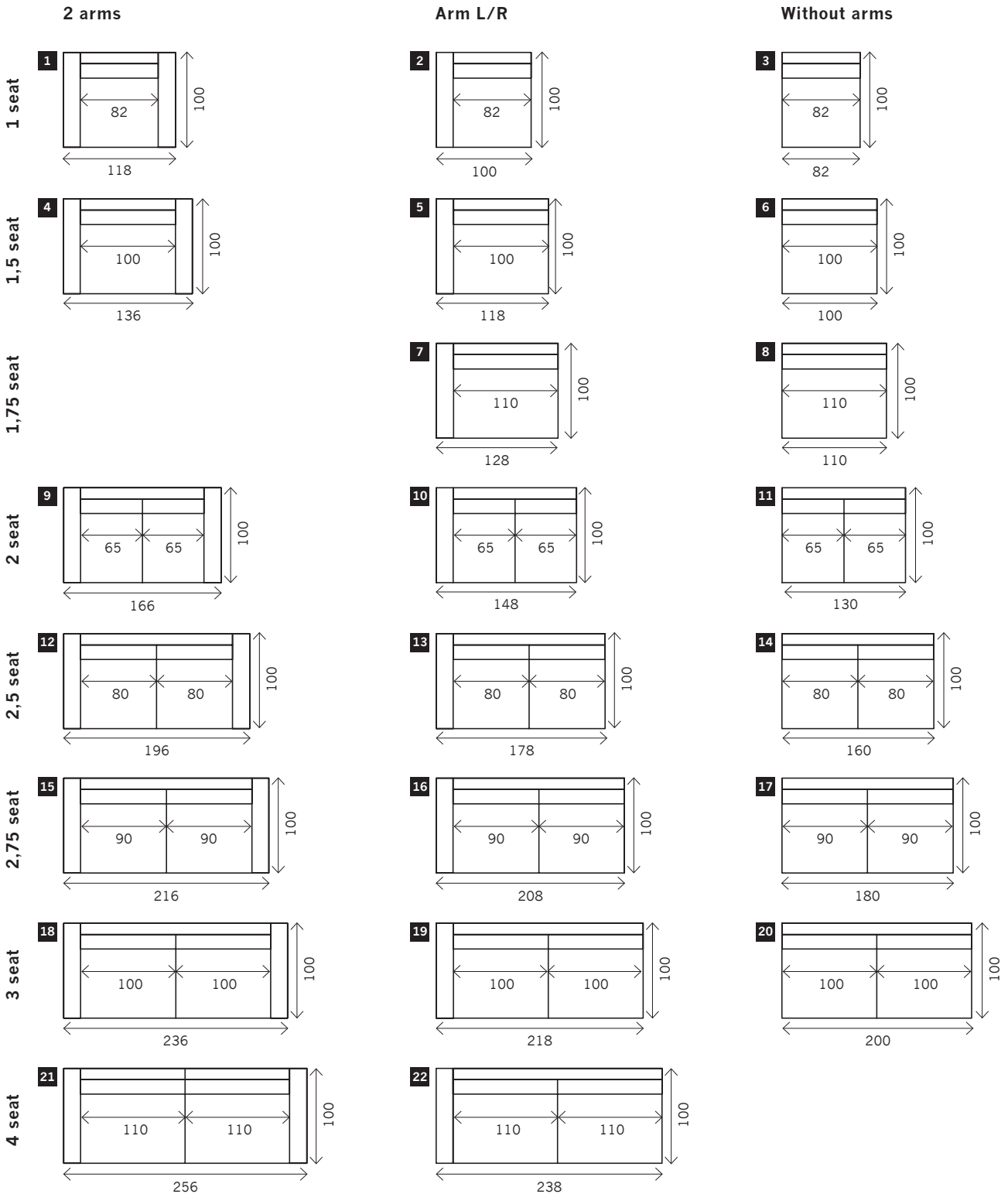

Corner

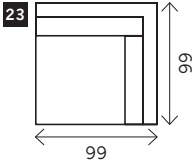

Pouf

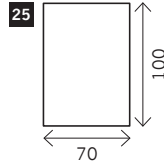
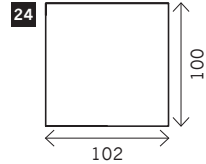

Dormeuse L/R

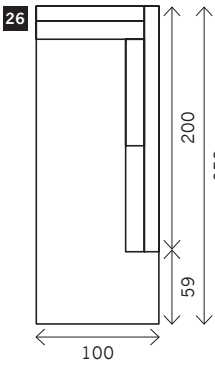

Hoeksofa L/R

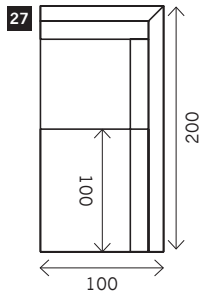

Lounger XXL L/R

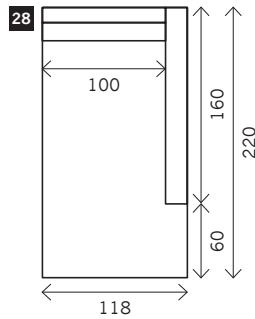

Ligelement L/R

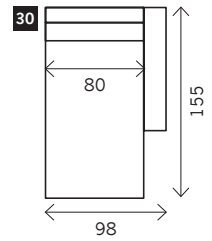
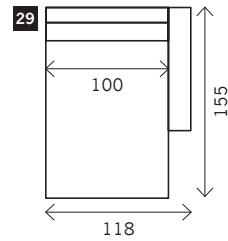

Examples corner sofas

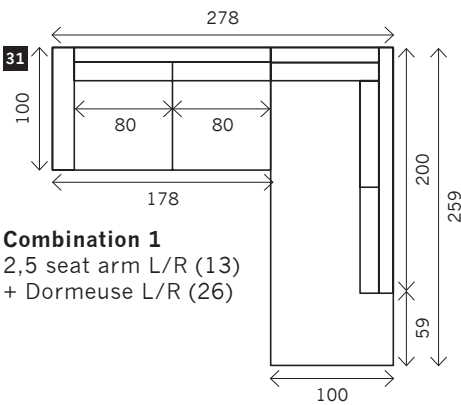

Combination 1
2,5 seat arm L/R (13)
+ Dormeuse L/R (26)

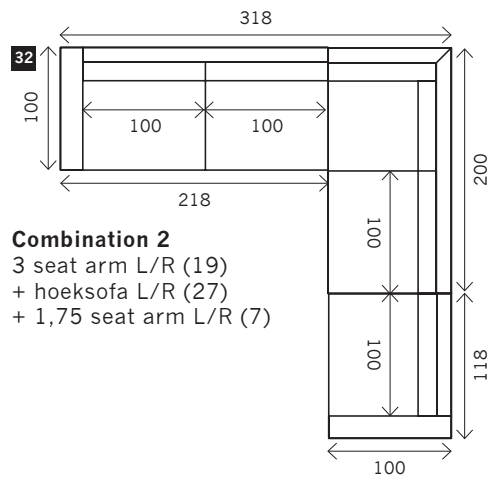

Combination 2
3 seat arm L/R (19)
+ hoeksofa L/R (27)
+ 1,75 seat arm L/R (7)

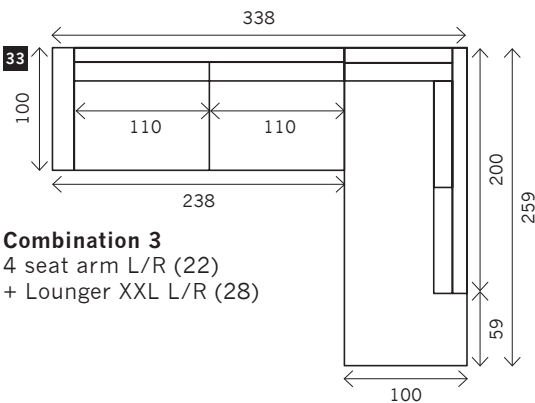

Combination 3
4 seat arm L/R (22)
+ Lounger XXL L/R (28)

Norman

Width arms: 25 cm
Height legs: 18 cm
Sitting height: ca. 42 cm
Total height: ca. 90 cm
Total depth: ca. 108 cm



2 arms

Arm L/R

Without arms

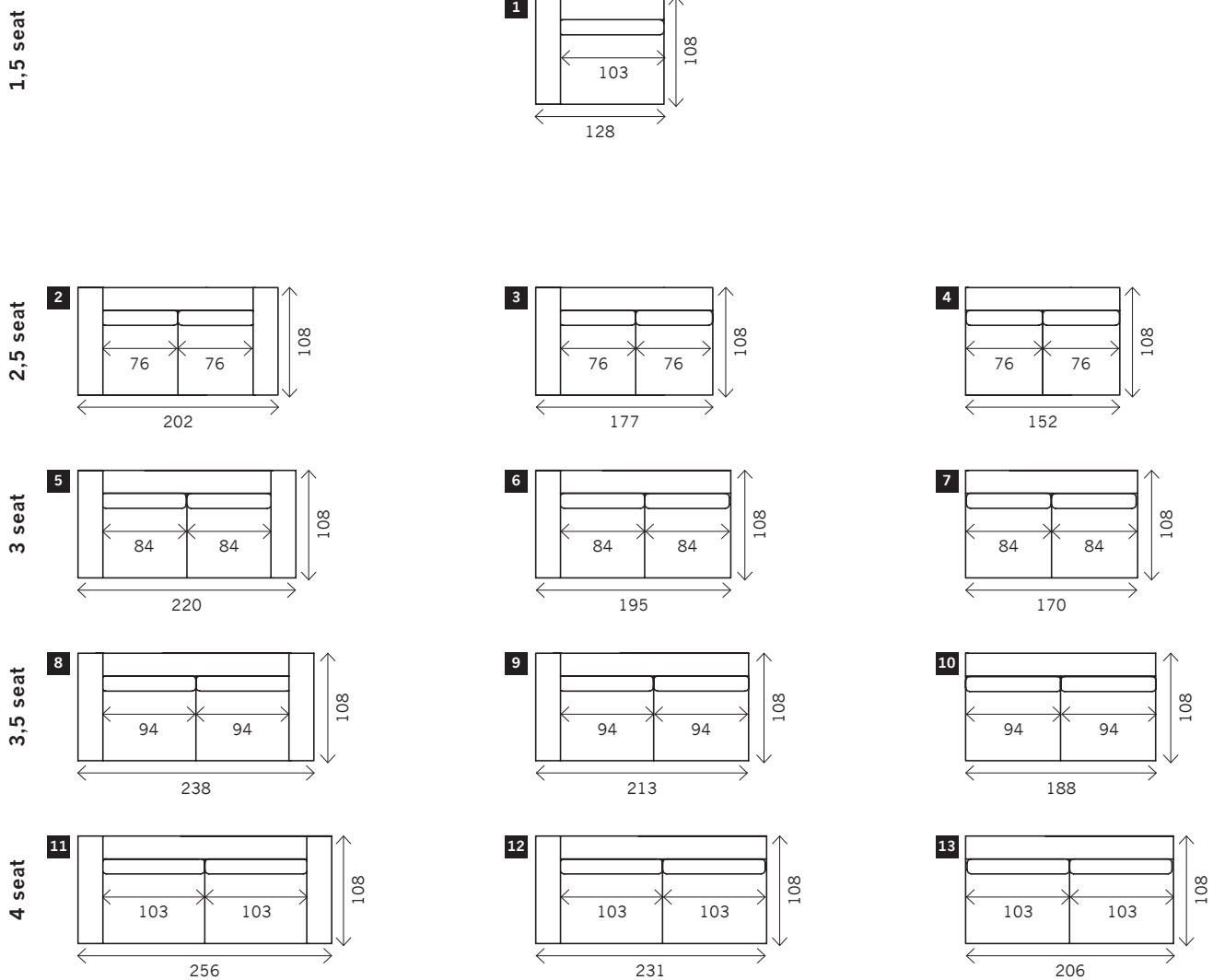

Corner L/R

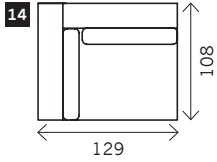

Pouf

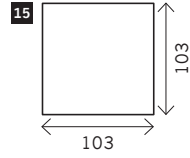

Side table

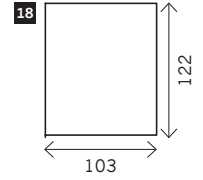
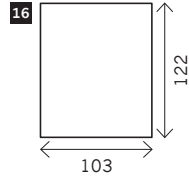
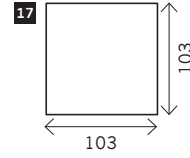

Longchair L/R

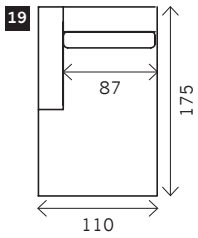

Meridienne L/R

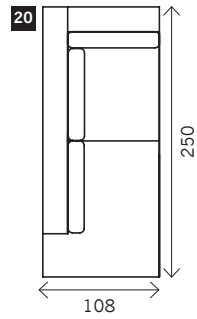

Terminal L/R

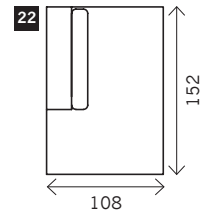
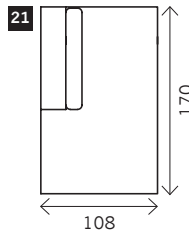

Examples corner sofas

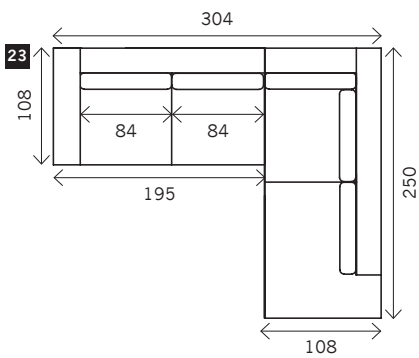

Combination 1
 3 seat arm L/R (6)
 + Meridienne L/R (20)

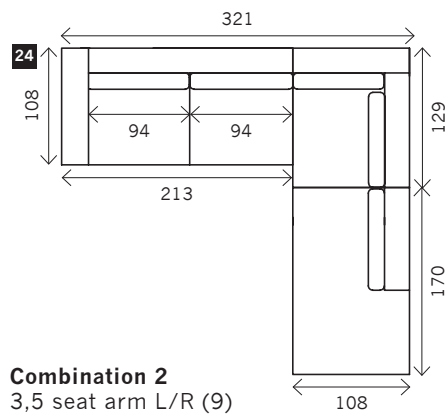

Combination 2
 3,5 seat arm L/R (9)
 + Corner L/R (14)
 + Terminal L/R (21)

Pauline

Width arms: 18 cm
Height legs: 10 cm
Sitting height: ca. 45 cm
Total height: ca. 86 cm
Total depth: ca. 99 cm

Option:
Without skirt



2 arms

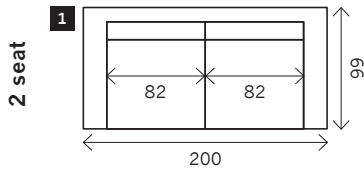

Arm L/R

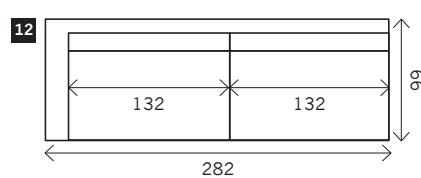
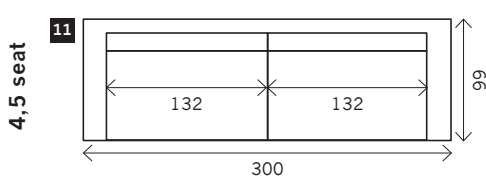
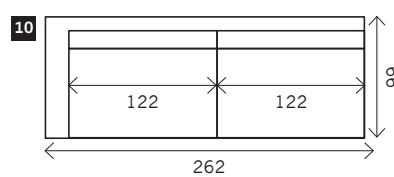
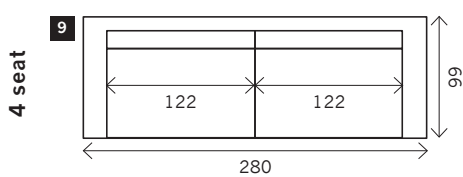
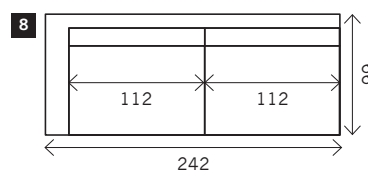
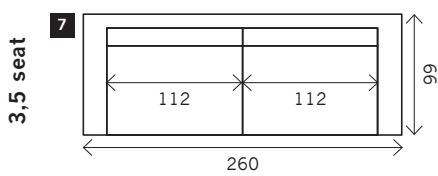
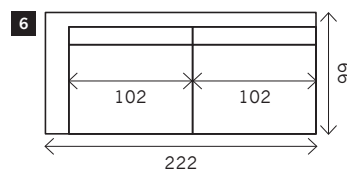
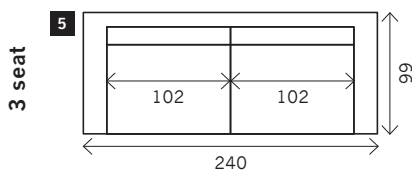
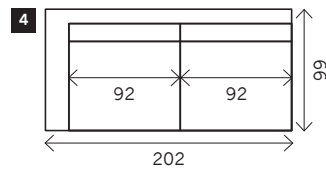
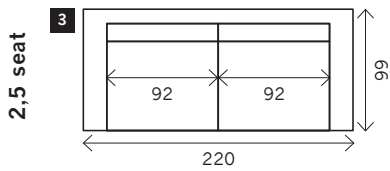
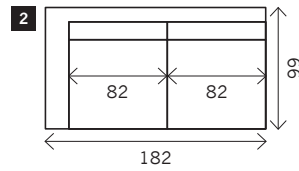

Corner

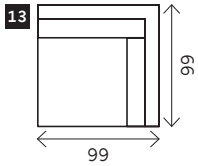

Meridienne L/R

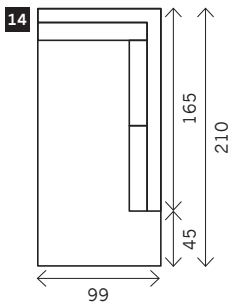

Longchair L/R

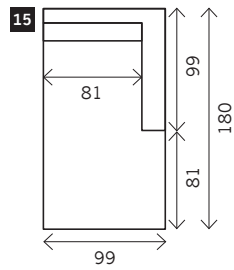

Examples corner sofas

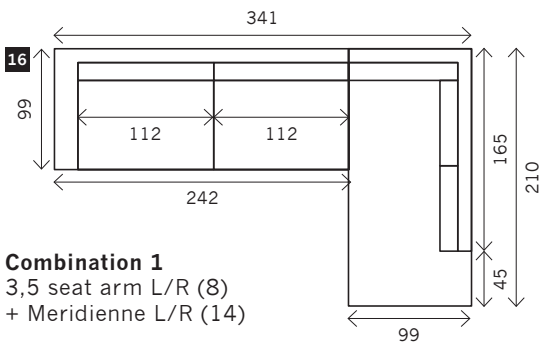

Combination 1
3,5 seat arm L/R (8)
+ Meridienne L/R (14)

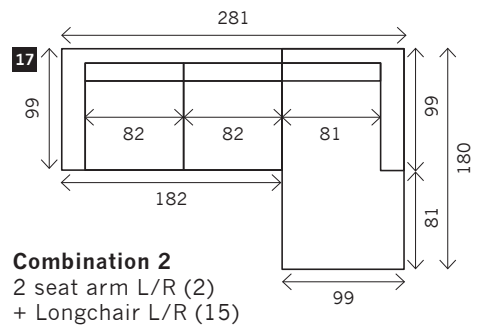

Combination 2
2 seat arm L/R (2)
+ Longchair L/R (15)

Selva

Width arms: 24 cm
Height legs: 12-18 cm
Sitting height: ca. 45 cm
Total height: ca. 98 cm
Total depth: ca. 105 cm

Legs: black metal



2 arms

Arm L/R

Without arms

1 seat

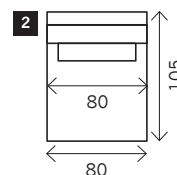
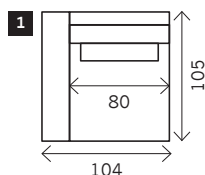

1,5 seat

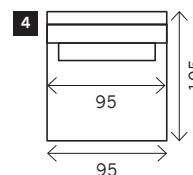
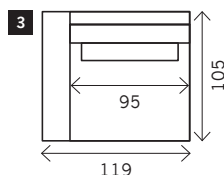

3 seat

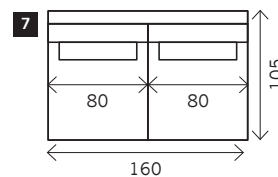
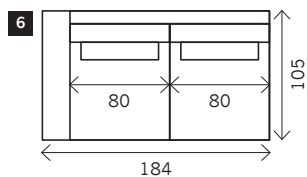
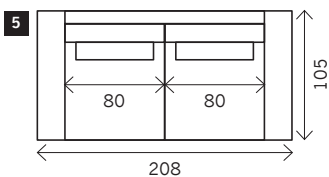

4 seat

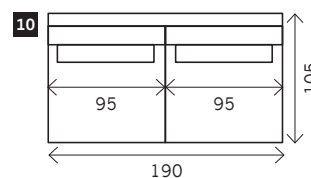
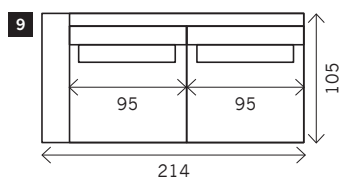
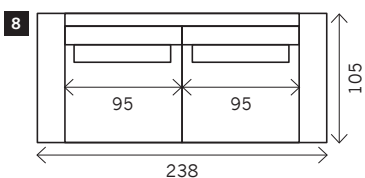

Corner

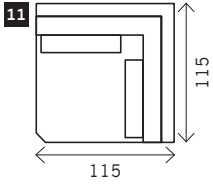

Pouf

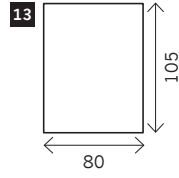
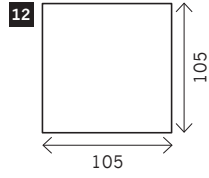

Longchair L/R

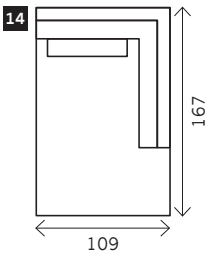

Examples corner sofas

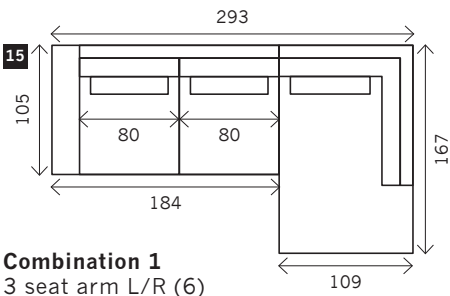

Combination 1
3 seat arm L/R (6)
+ Longchair L/R (14)

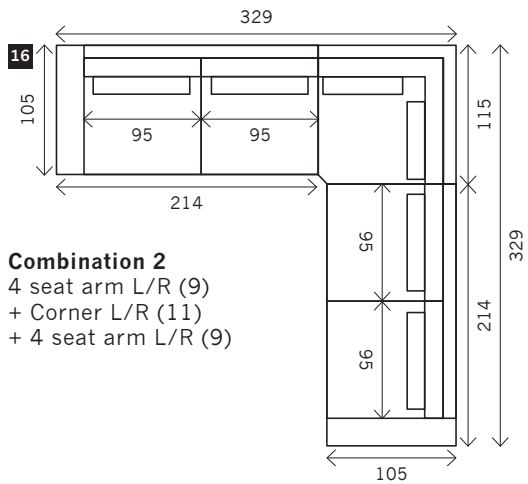

Combination 2
4 seat arm L/R (9)
+ Corner L/R (11)
+ 4 seat arm L/R (9)

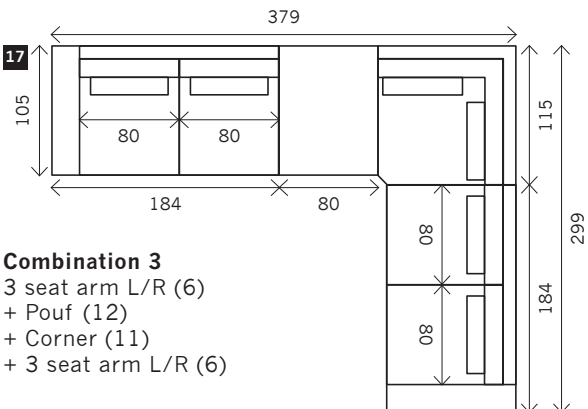

Combination 3
3 seat arm L/R (6)
+ Pouf (12)
+ Corner (11)
+ 3 seat arm L/R (6)

Sienna

Width arms: 18 cm
Height legs: 5 cm
Sitting height: ca. 44 cm
Total height: ca. 86 cm
Total depth: ca. 99 cm

Option:
Without skirt



2 arms

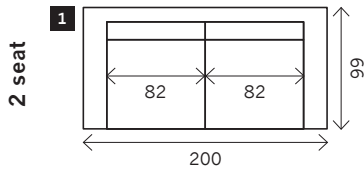

Arm L/R

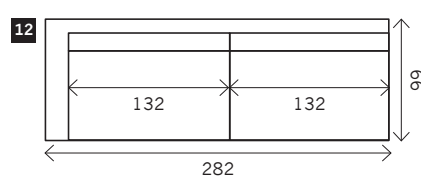
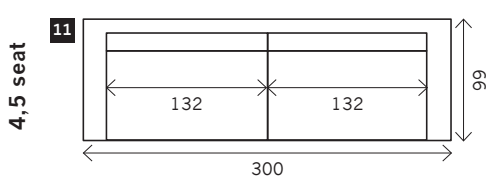
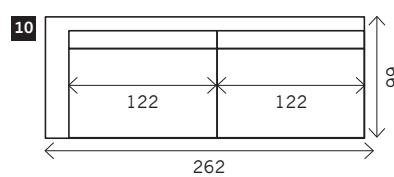
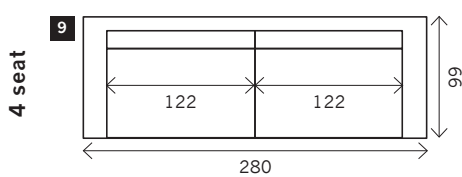
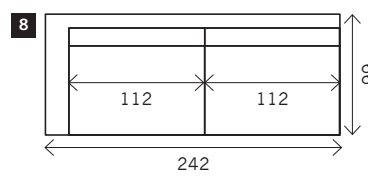
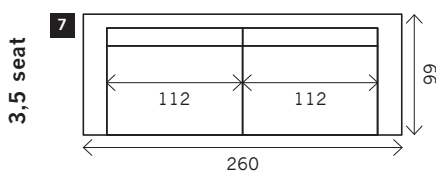
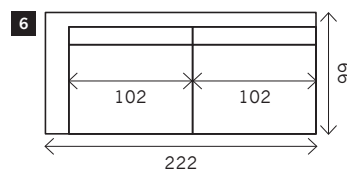
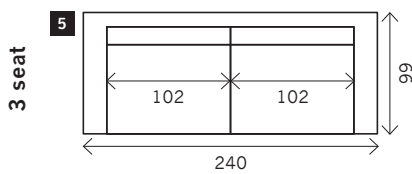
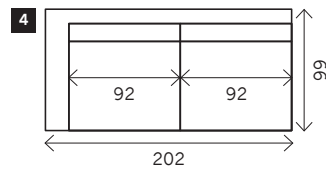
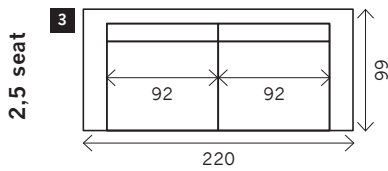
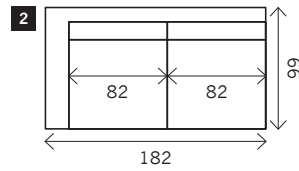

Corner

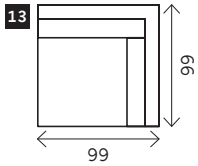

Meridienne L/R

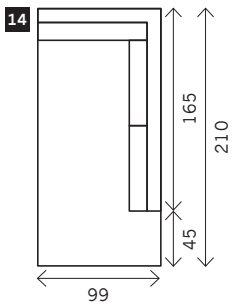

Longchair L/R

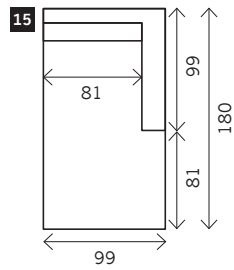

Examples corner sofas

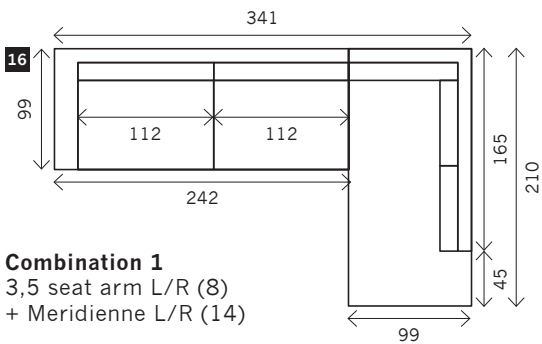

Combination 1
3,5 seat arm L/R (8)
+ Meridienne L/R (14)

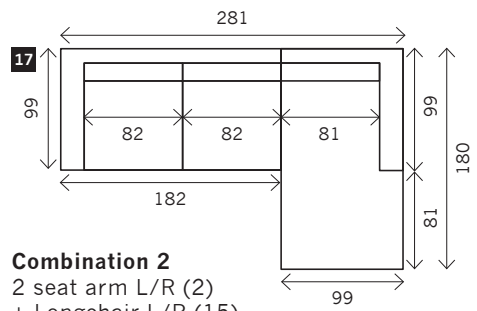

Combination 2
2 seat arm L/R (2)
+ Longchair L/R (15)

Torino

Width arms: 20 cm
Height legs: 15 cm
Sitting height: ca. 46 cm
Total height: ca. 77 cm
Total depth: ca. 82 cm

Toss cushions 45 x 45 cm:
 Seats with 2 arms: 2x
 Seats with 1 arm, longchair, meridienne: 1x



2 arms

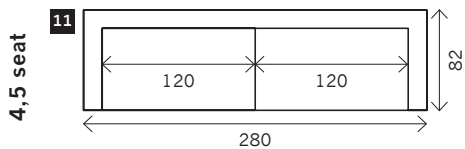
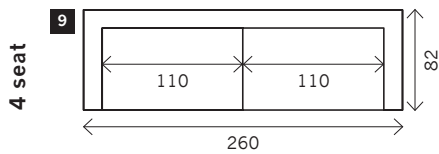
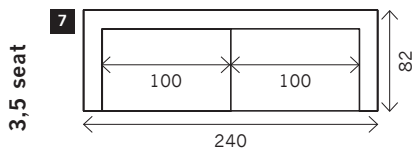
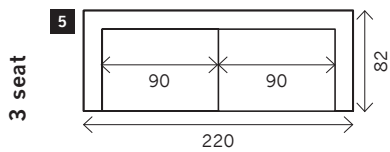
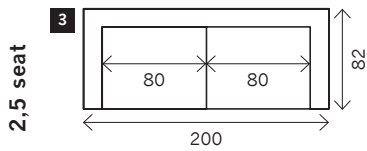
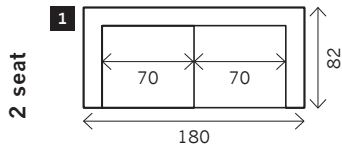

Arm L/R

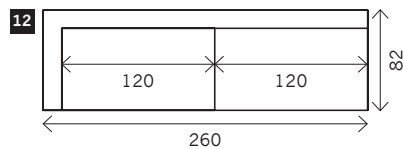
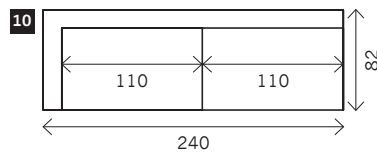
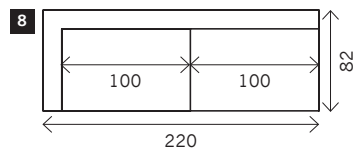
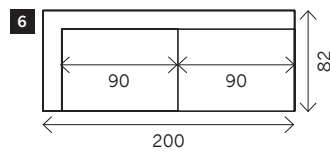
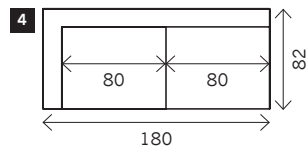
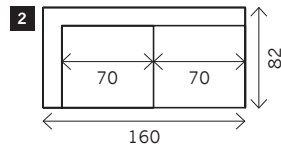

Corner

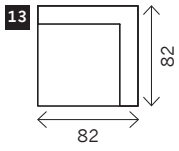

Pouf

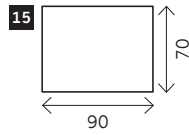
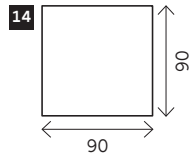

Meridienne L/R

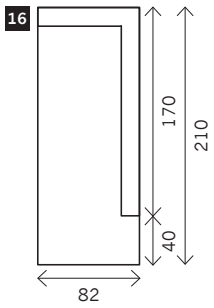

Longchair L/R

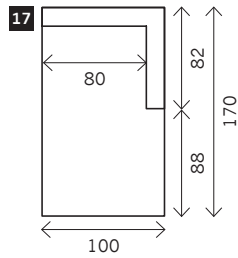

Examples corner sofas

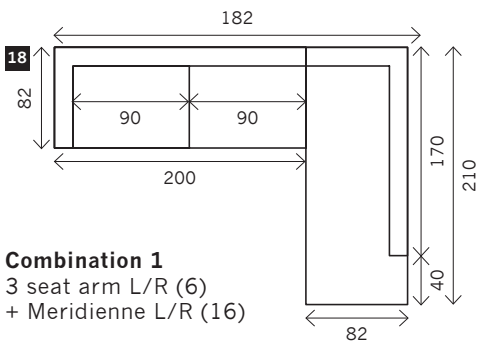

Combination 1
3 seat arm L/R (6)
+ Meridienne L/R (16)

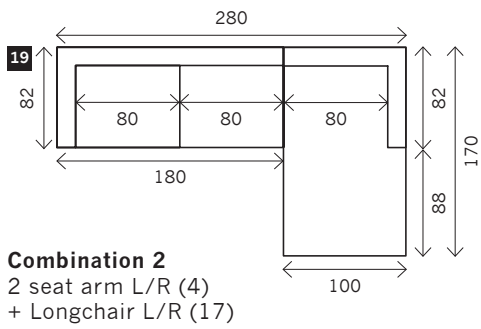

Combination 2
2 seat arm L/R (4)
+ Longchair L/R (17)

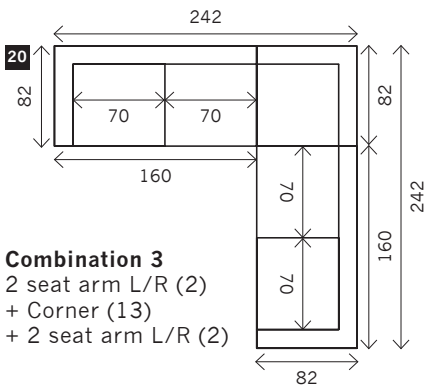

Combination 3
2 seat arm L/R (2)
+ Corner (13)
+ 2 seat arm L/R (2)

Tulsa

Width arms: 24 cm
Height legs: 8 cm
Sitting height: ca. 44 cm
Total height: ca. 92 cm
Total depth: ca. 108 cm



2 arms

1 seat

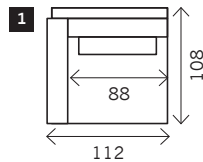

1,5 seat

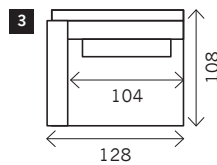

3 seat

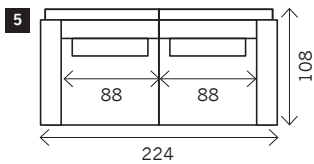

4 seat

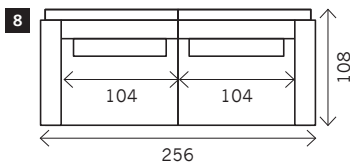

Arm L/R

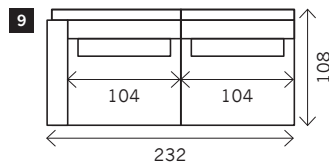
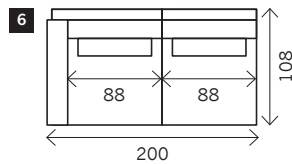

Without arms

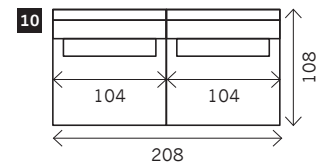
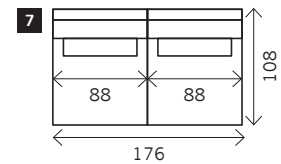
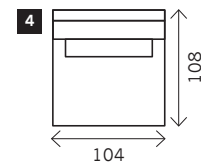
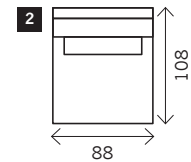

2 wings without arms

1 seat

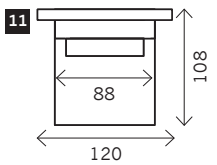

1,5 seat

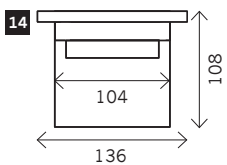

3 seat

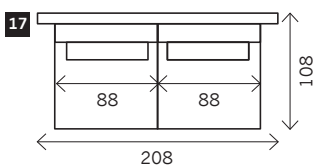

4 seat

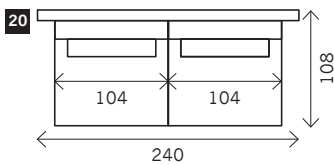

Arm L/R, wing L/R

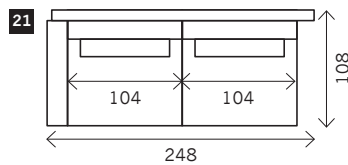
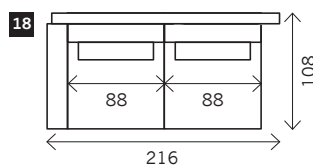
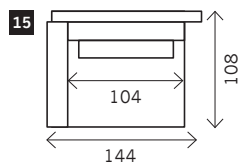
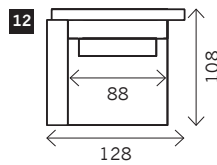

Without arms, wing L/R

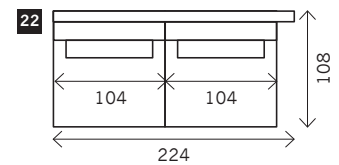
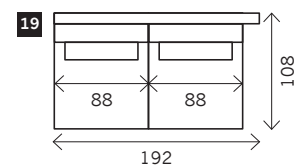
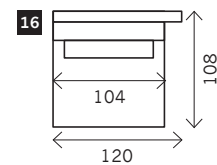
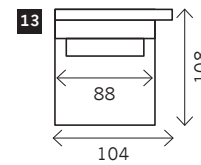

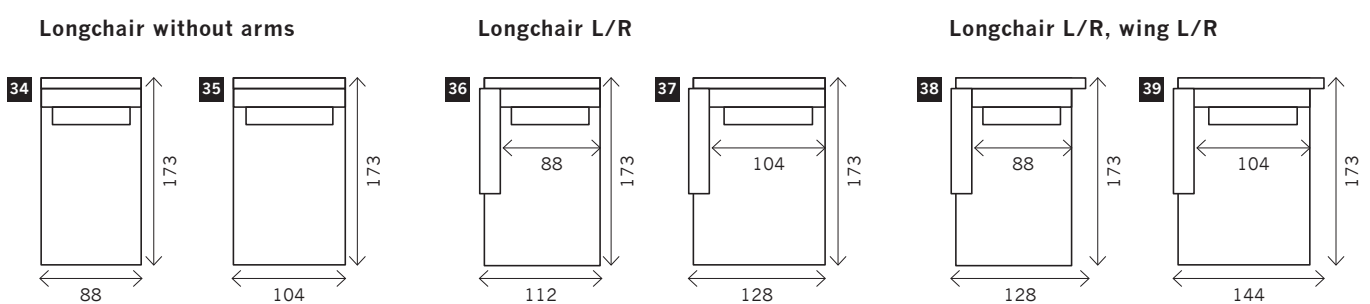
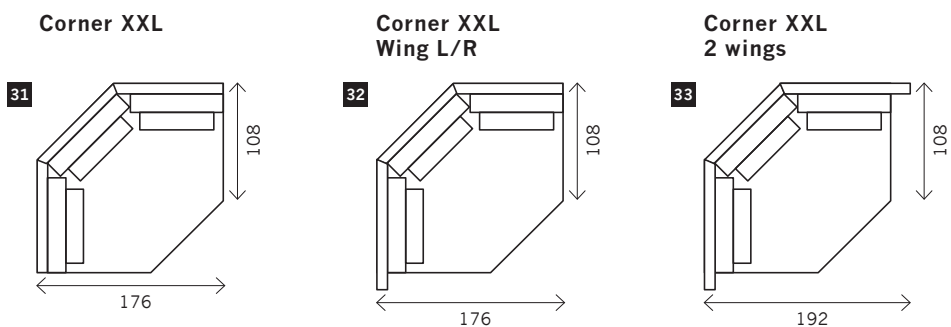
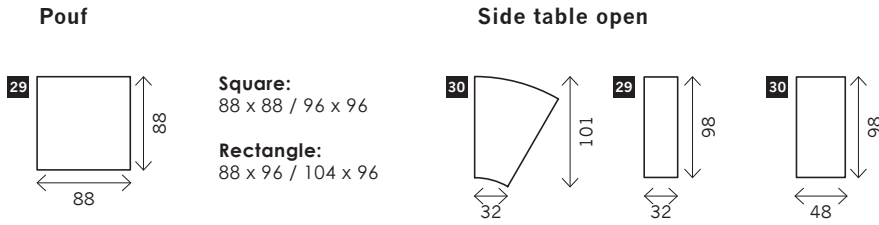
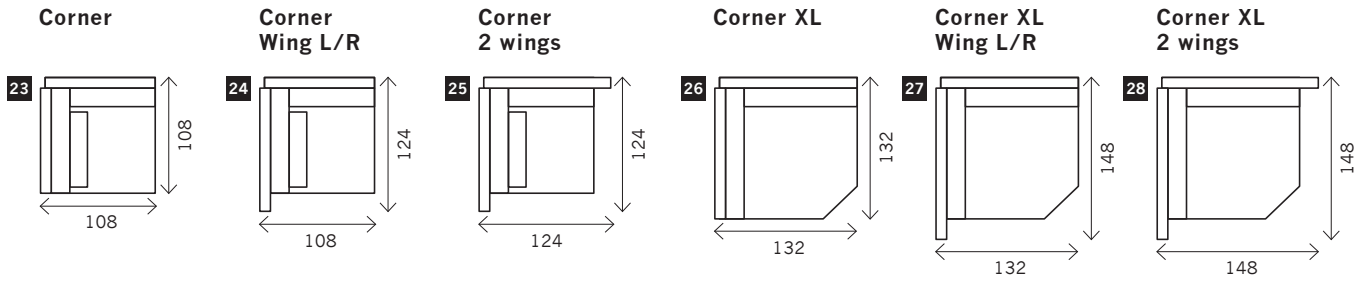

Examples corner sofas

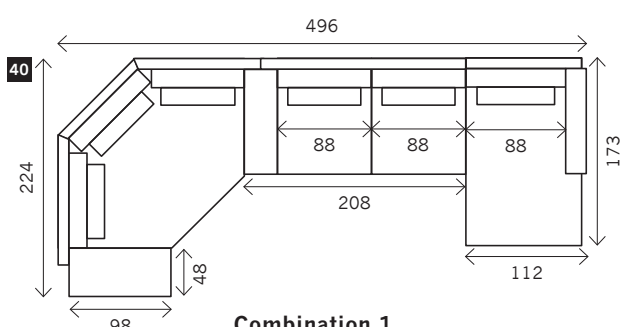

Combination 1
 Side table open (30)
 + Corner XXL 2 wings (33)
 + Side table open (29)
 + 3 seat without arms, wing L/R (19)
 + Longchair L/R (36)

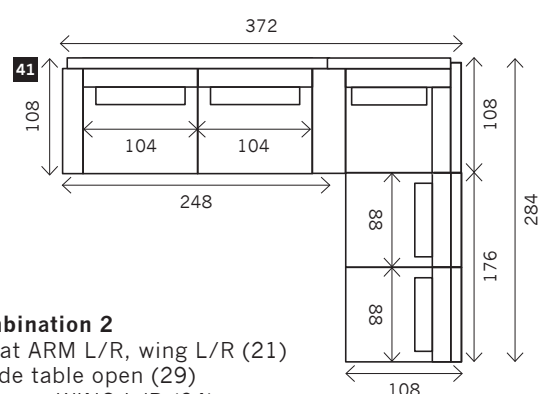

Combination 2
 4 seat ARM L/R, wing L/R (21)
 + Side table open (29)
 + Corner WING L/R (24)
 + 3 seat without arms (7)

Yukon

Width arms: 19 cm
Height legs: 17 cm
Sitting height: ca. 43 cm
Total height: ca. 83-104 cm
Total depth: ca. 105-112 cm

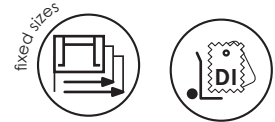

2 arms

Arm L/R

Without arms

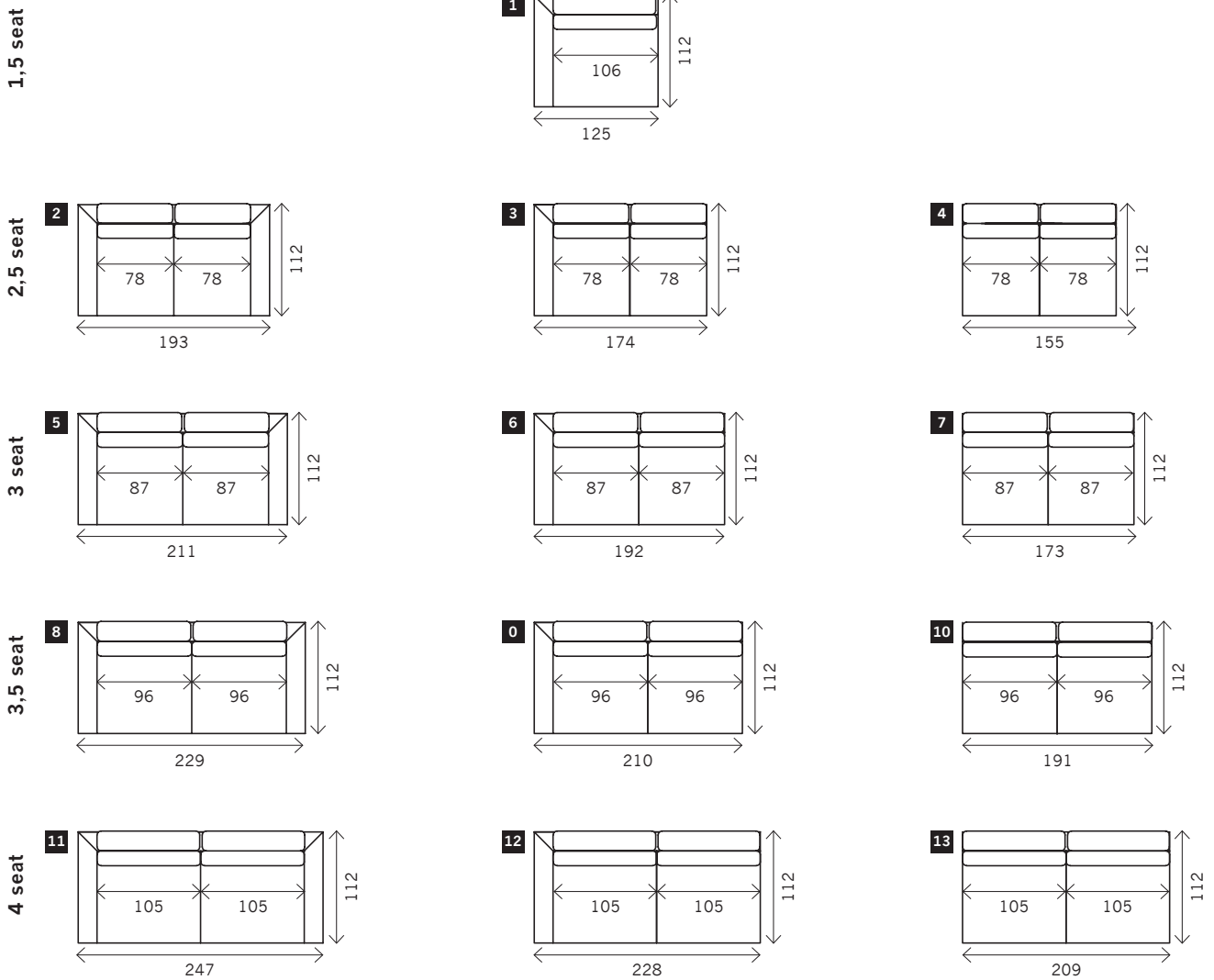

Corner

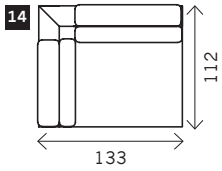

Pouf

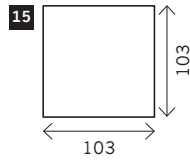

Side table

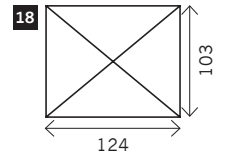
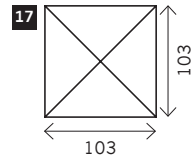
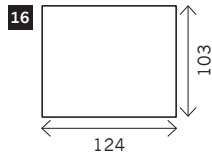

Meridienne L/R

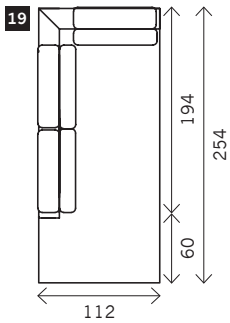

Longchair L/R

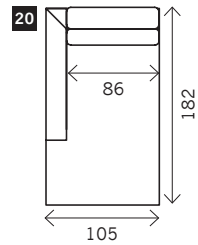

Terminal element L/R

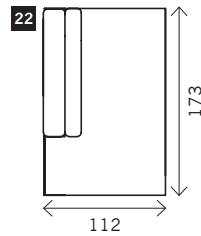
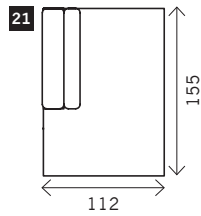

Examples corner sofas

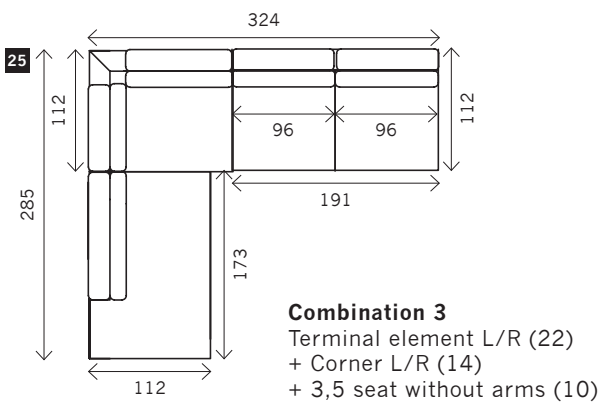
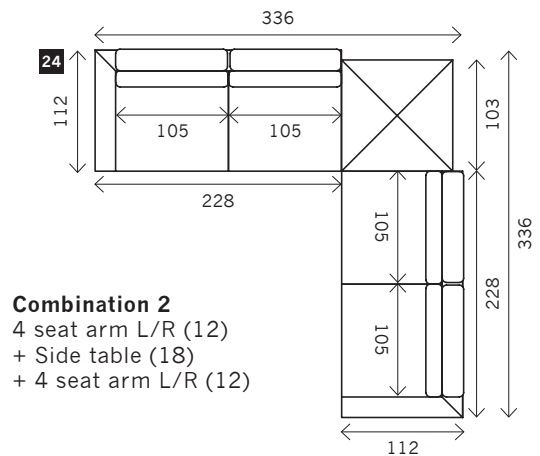
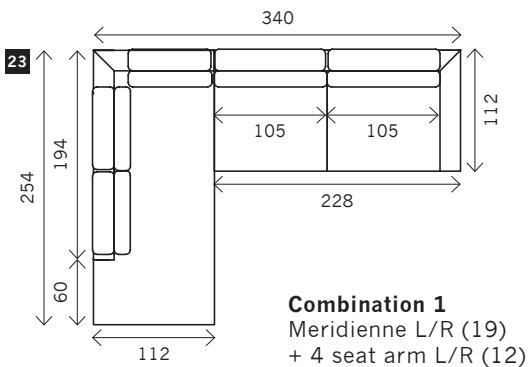

Zermatt

Width arms: 18 cm
Height legs: 10 cm
Sitting height: ca. 45 cm
Total height: ca. 89 cm
Total depth: ca. 99 cm



2 arms

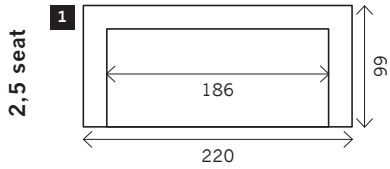

Arm L/R

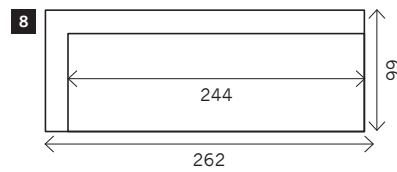
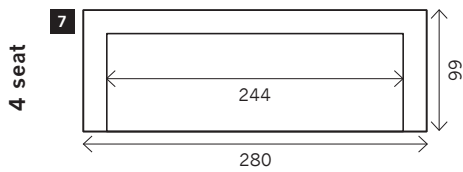
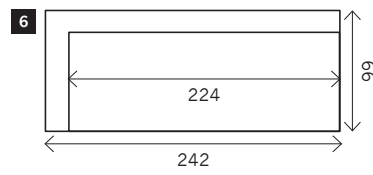
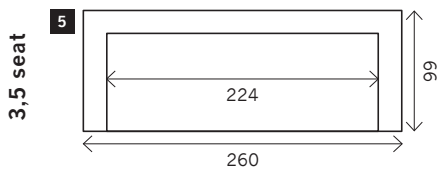
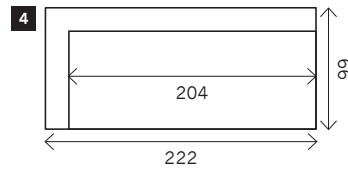
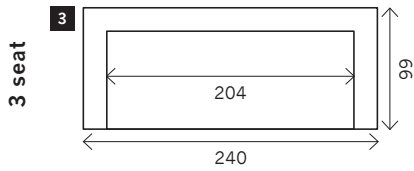
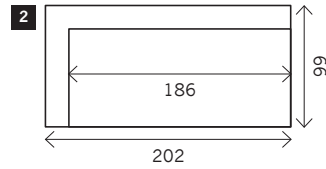

Corner

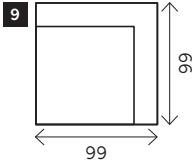

Meridienne L/R

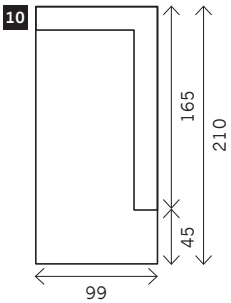

Longchair L/R

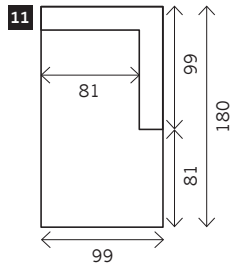

Examples corner sofas

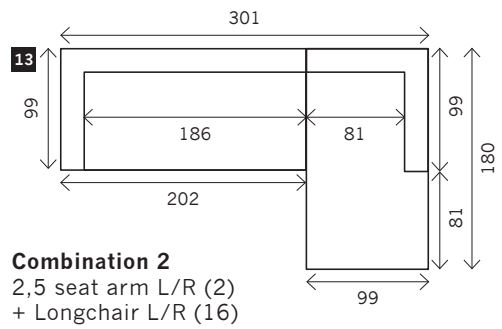
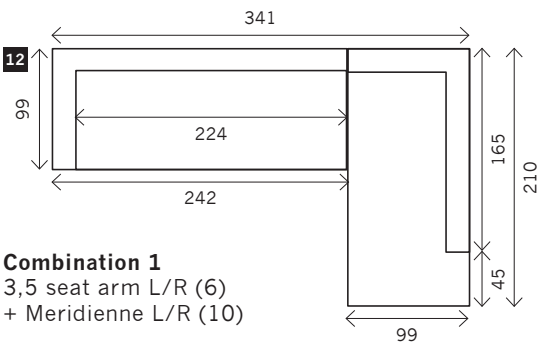

DINING TABLES 'CO'

Choose a shape & size

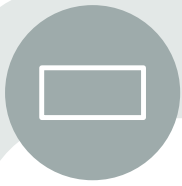

RECTANGLE

160 x 90 cm
190 x 100 cm
240 x 110 cm
280 x 120 cm
320 x 120 cm

Optional: rounded corners or extension



TONNEAU RECTANGLE

190 x 100 cm
240 x 110 cm
280 x 120 cm
320 x 130 cm

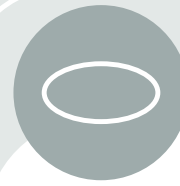

OVAL

240 x 120 cm
280 x 120 cm
320 x 140 cm

Choose a base

VERSATILE

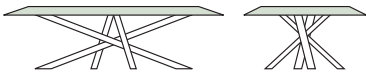

TITAN

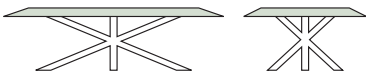

ELEONORE

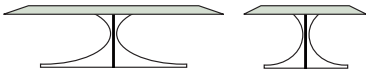

CARAT

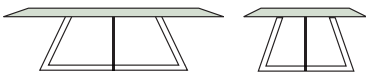

CROSS

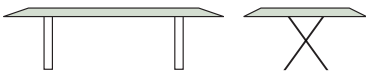

UGO

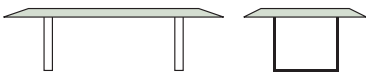

TOPAZE

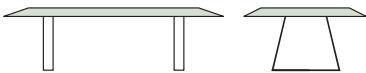

NEW YORK

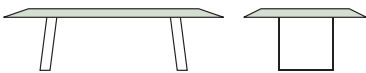

VERSATILE

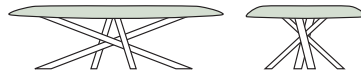

TITAN

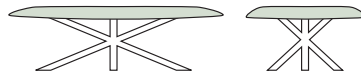

ELEONORE

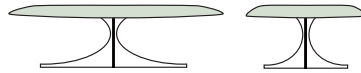

CARAT

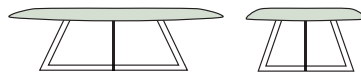

VICTORIA



UGO

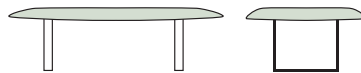

BYBLOS



VERSATILE

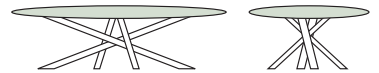

TITAN

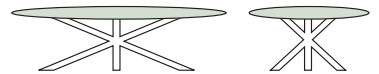

ELEONORE

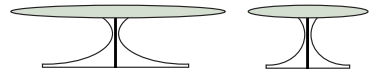

CARAT

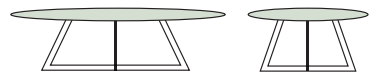

VICTORIA





ELISTONE

160 x 130 cm
 185 x 140 cm
 240 x 110 cm
 254 x 140 cm
 274 x 119 cm
 290 x 140 cm
 320 x 140 cm

VERSATILE

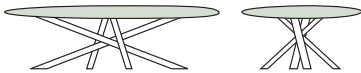

BENNATA

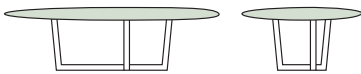

SYMPHONY

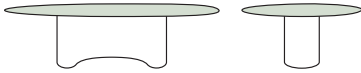

ROUND

dia 120 cm
 dia 140 cm
 dia 160 cm

Optional: *Tonneau*

VERSATILE

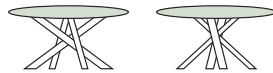

TITAN

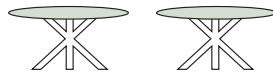

TOLBIAC

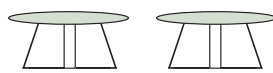

ACCADIA



TRIO

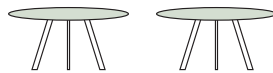

SAMBA

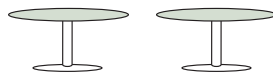

VENDOME

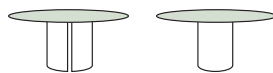

SQUARE

120 x 120 cm
 140 x 140 cm
 160 x 160 cm

Optional: *rounded corners or extension*

VERSATILE

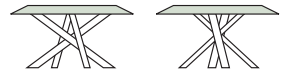

TITAN

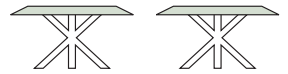

TOLBIAC

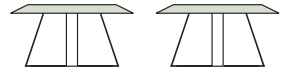

MELBOURNE

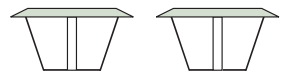

Charrell Home Interiors

Vossendaal 10 - 2440 Geel
Belgium

+32 (0)14/58 71 93
info@charrell.be
www.charrell.com

Follow us at:



All information in this catalog is without engagement, replaces all preceding information and can always be modified.
Charrell has the right to change the technical aspects of its products at any time and without further notice.
Colours en sizes of the products represented in this catalog may differ a bit from the original.
No part of this publication may be reproduced without written authorization of Charrell Home Interiors NV.
Charrell Home Interiors is a registered trademark.

Balanced luxury.
Made to stand out.

www.charrell.be